

Çizgileri tamamla ve aynı  
renge boya.

# Color by Number

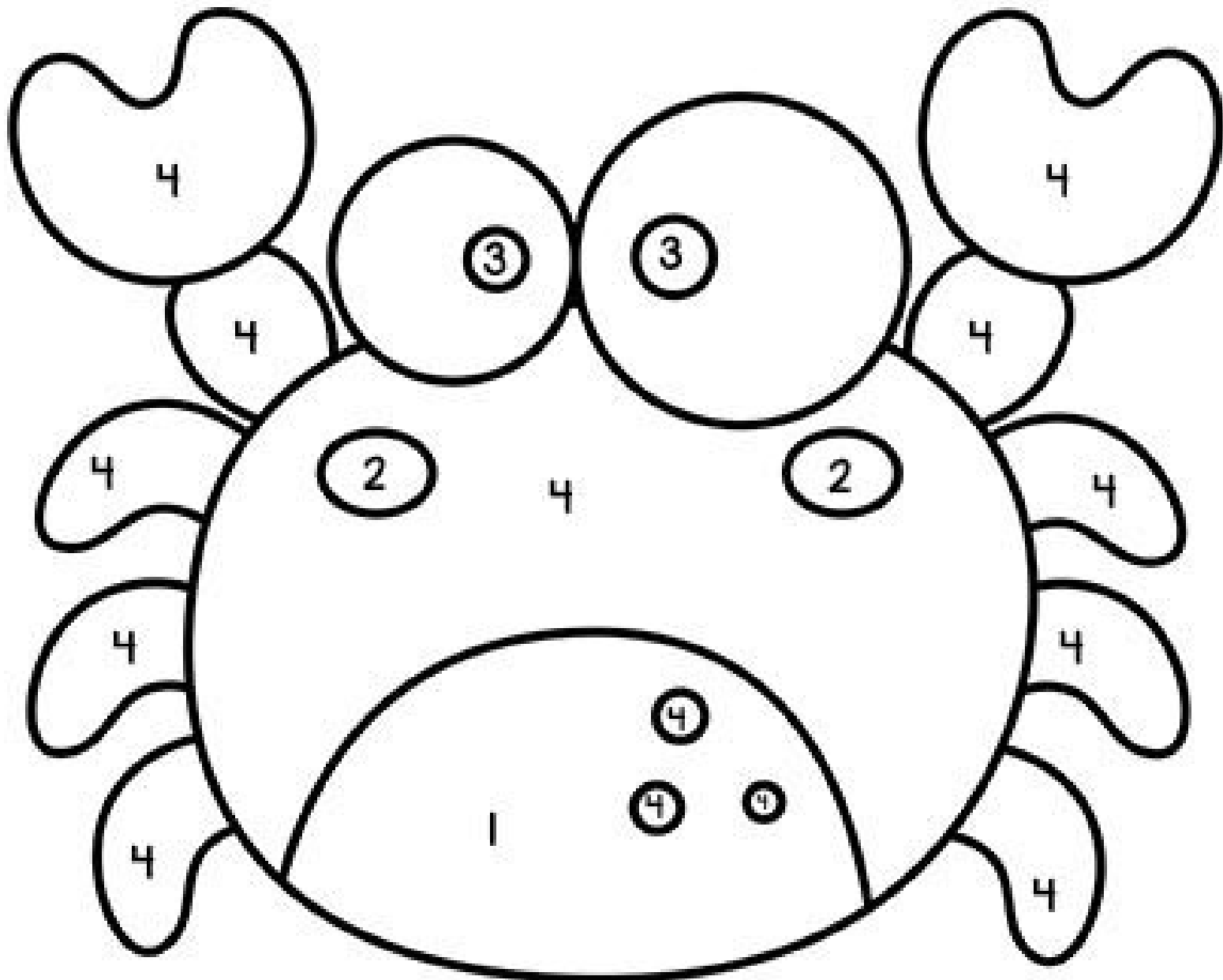

\* Her sırada tüylü olanların çemberini sarıya, tüysüz olanların çemberini yeşile boyar mısın?

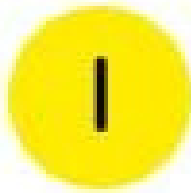
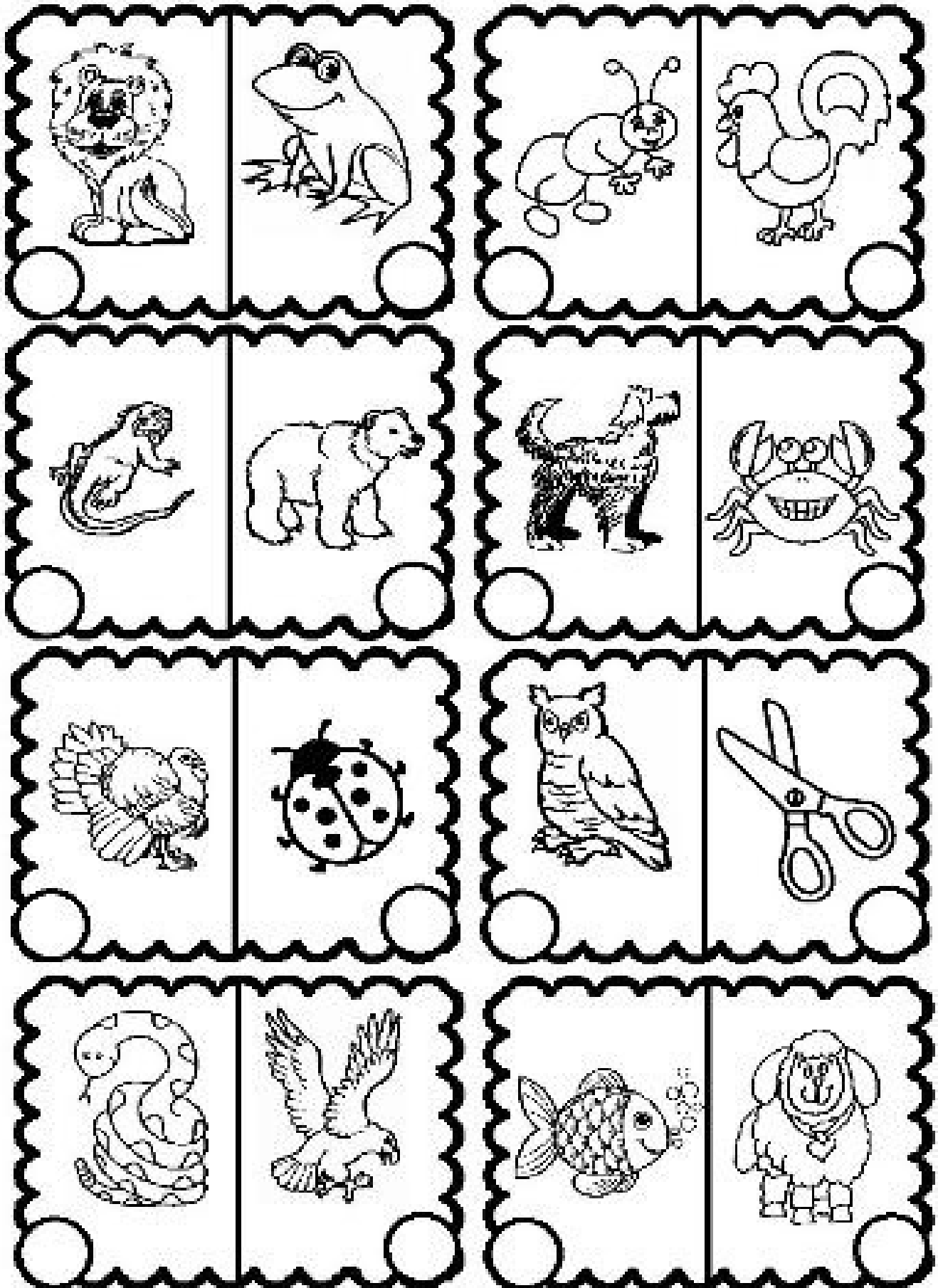

\* Sayfalarla kullanılan resimler yerli ve yabancı çeşitli internet sitelerinden alınmıştır. ÜCRETSİZ SAYFALAR

\* Hangileri tüylü, hangileri tüysüz? Tüylü hayvanların kalbini boyar mısın?

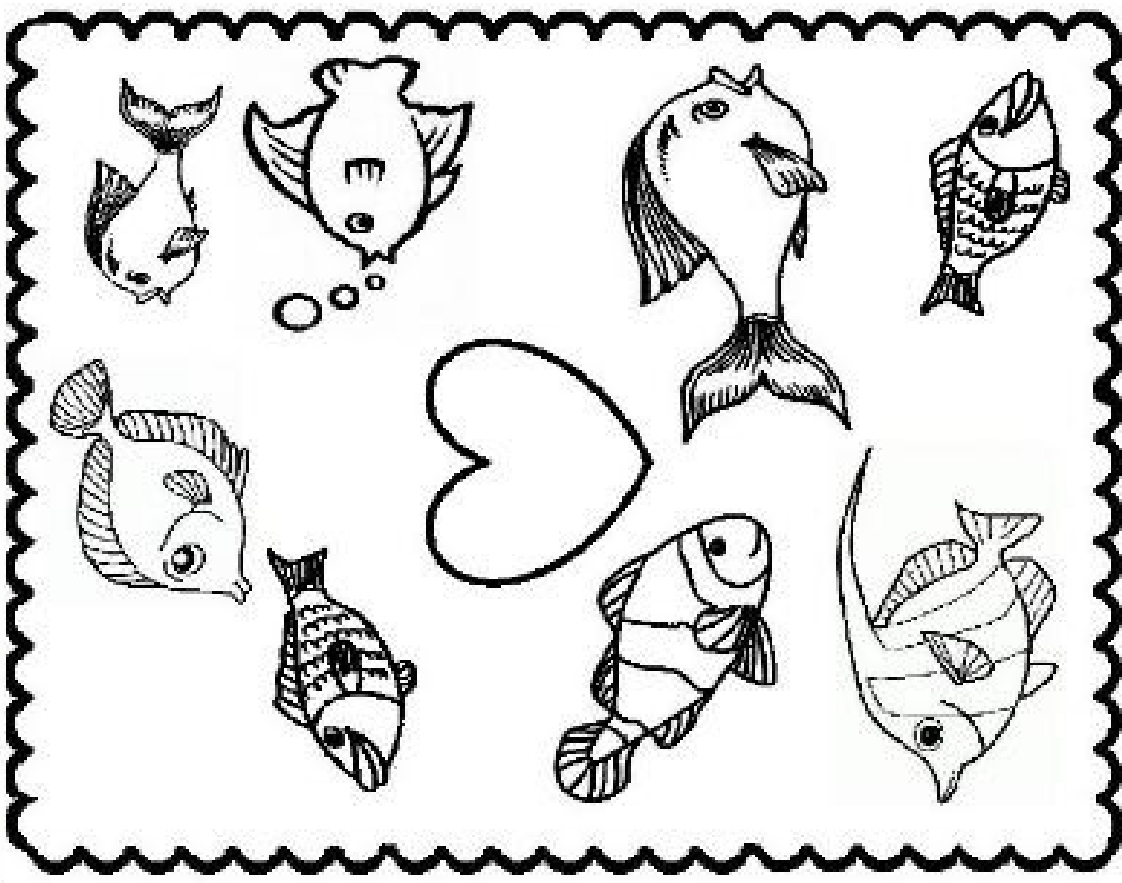
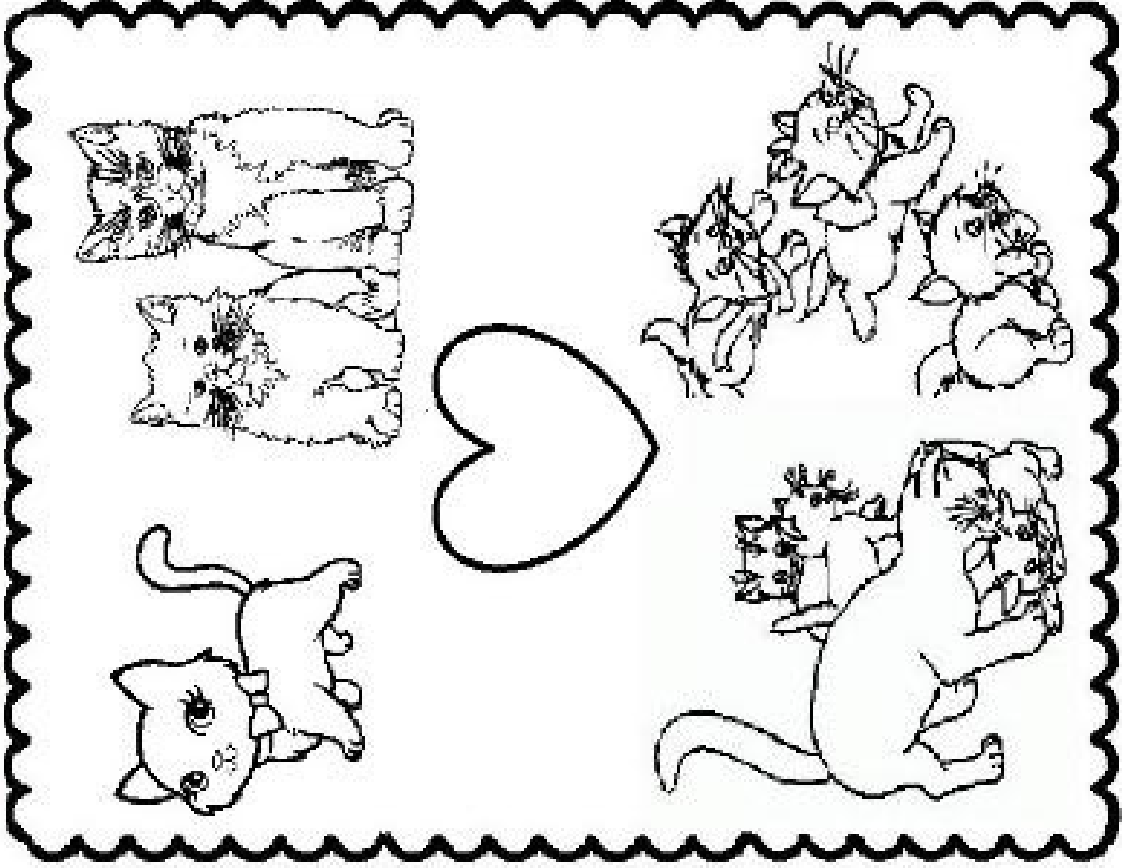

\* Sayfalarda kullanılan resimler, yerli ve yabancı çeşitli internet sitelerinden alınmıştır. ÜCRETSİZ SAYFALAR.

Tüysüz olanı boyarmısın?

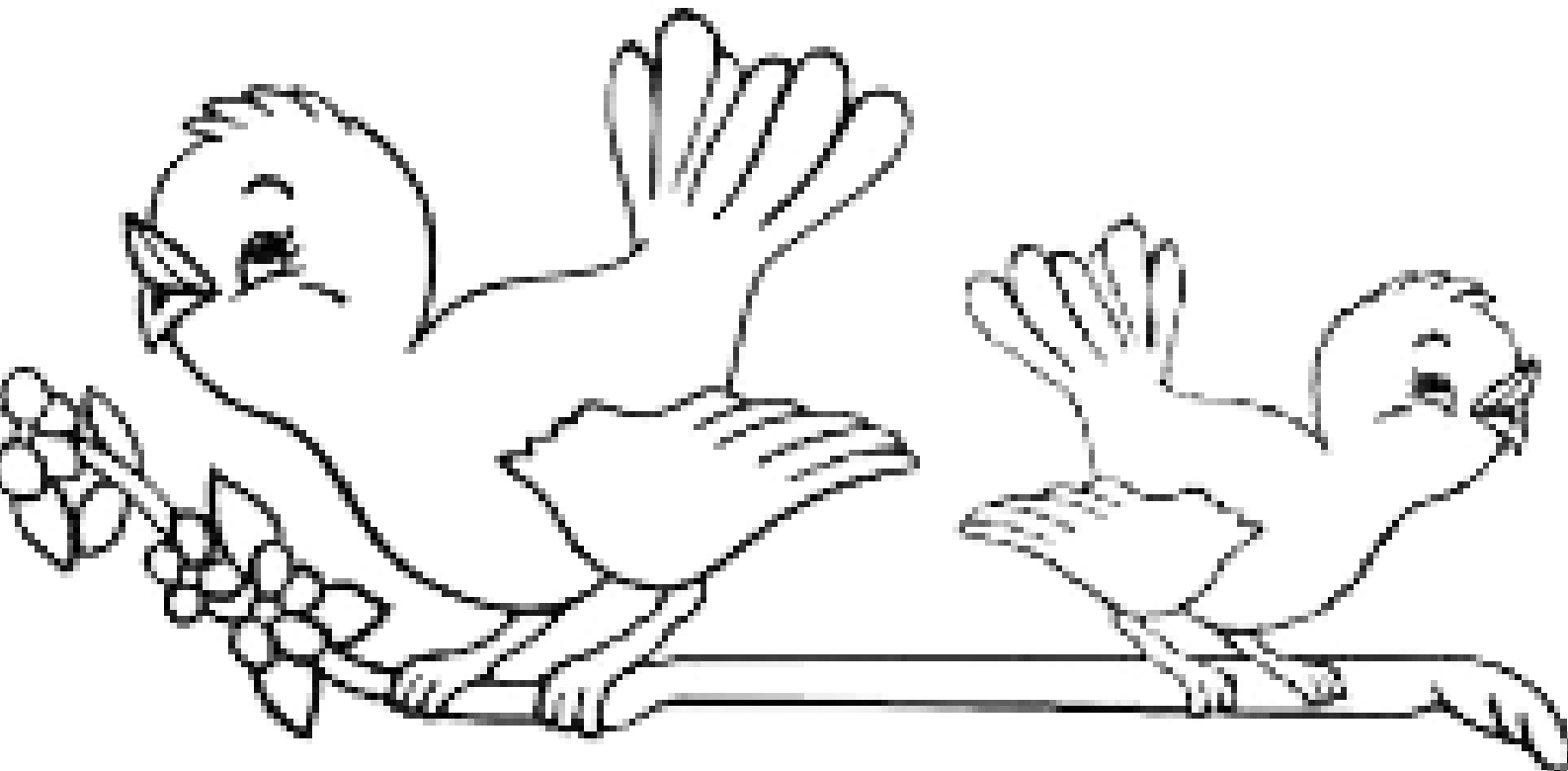
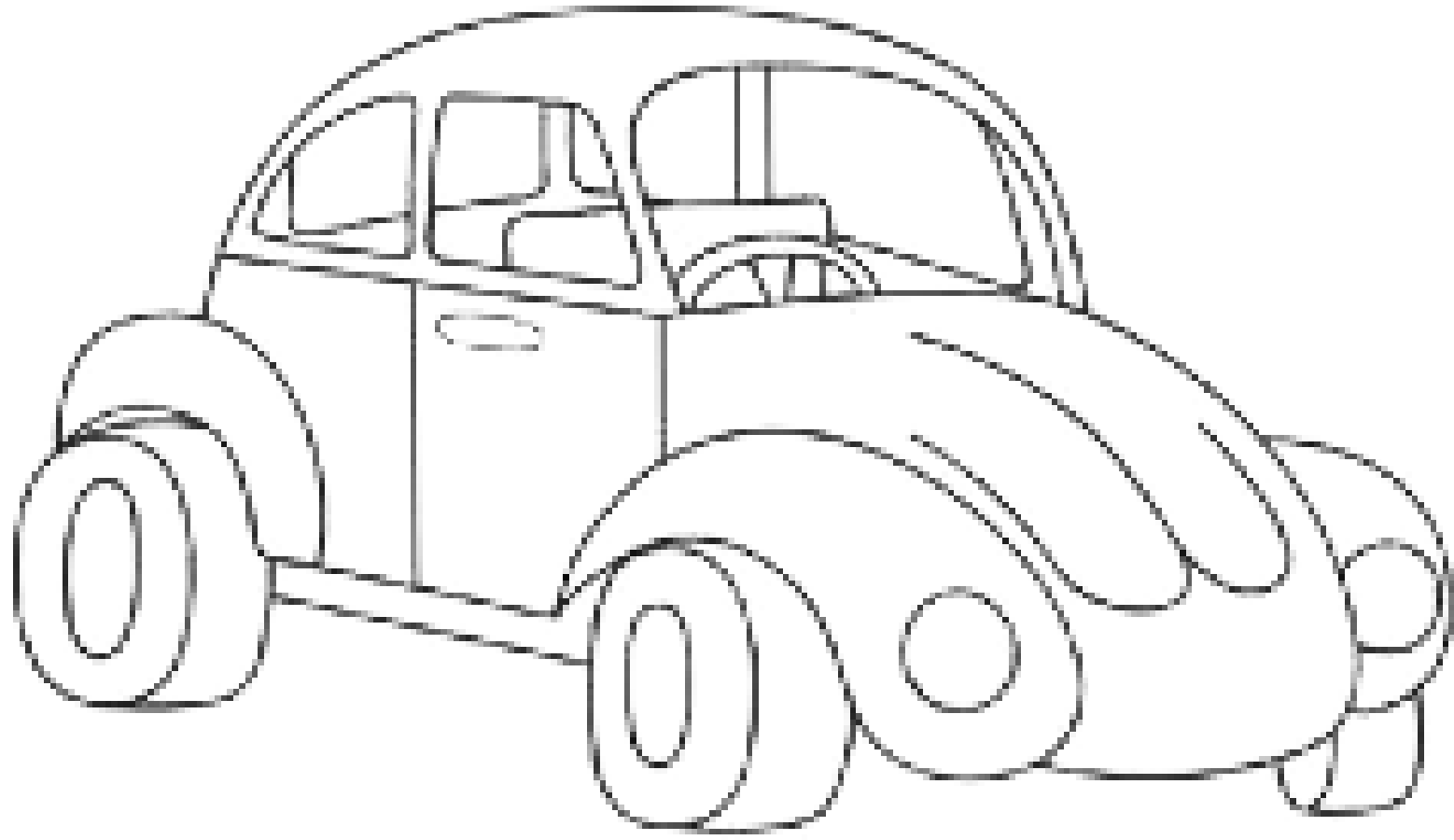

\* Hangisi tüylü, hangisi tüysüz? Tüysüz olanın çemberini boyar mısın?

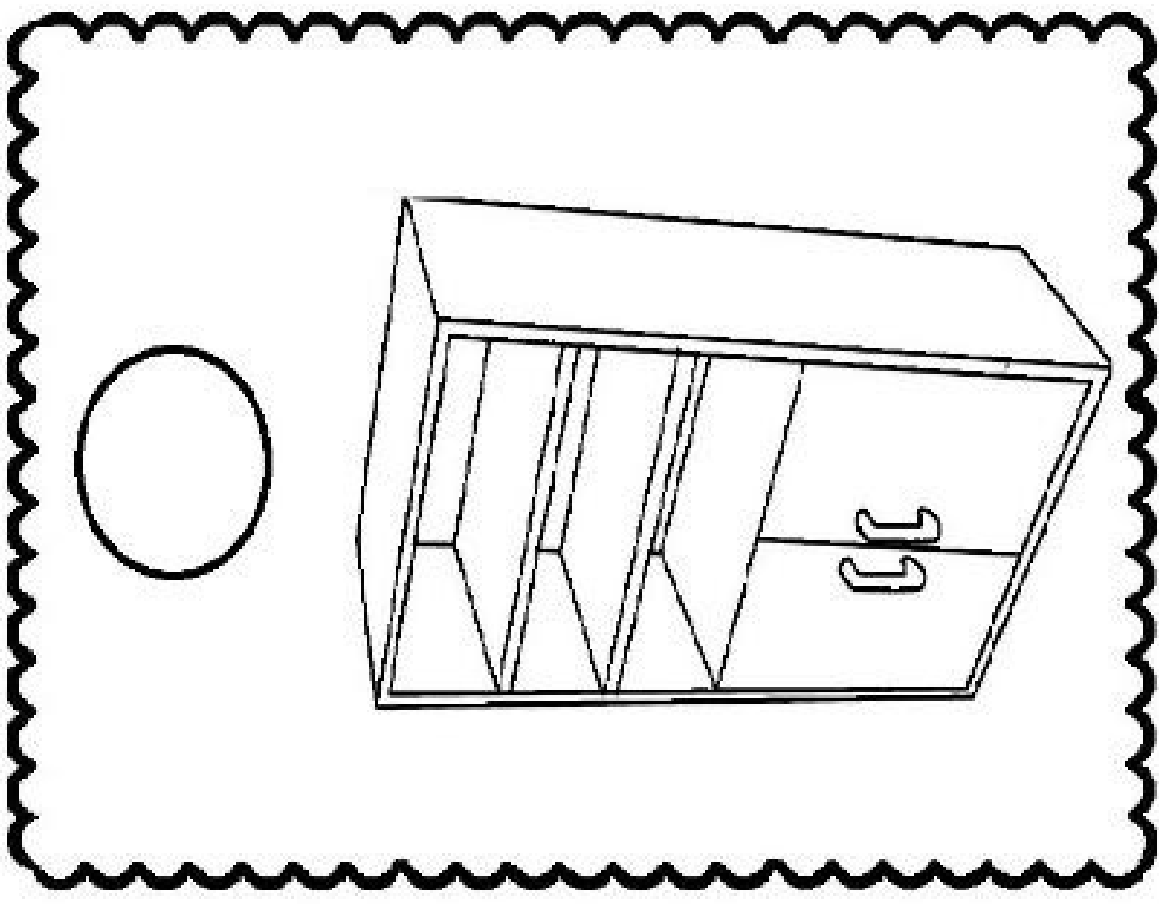
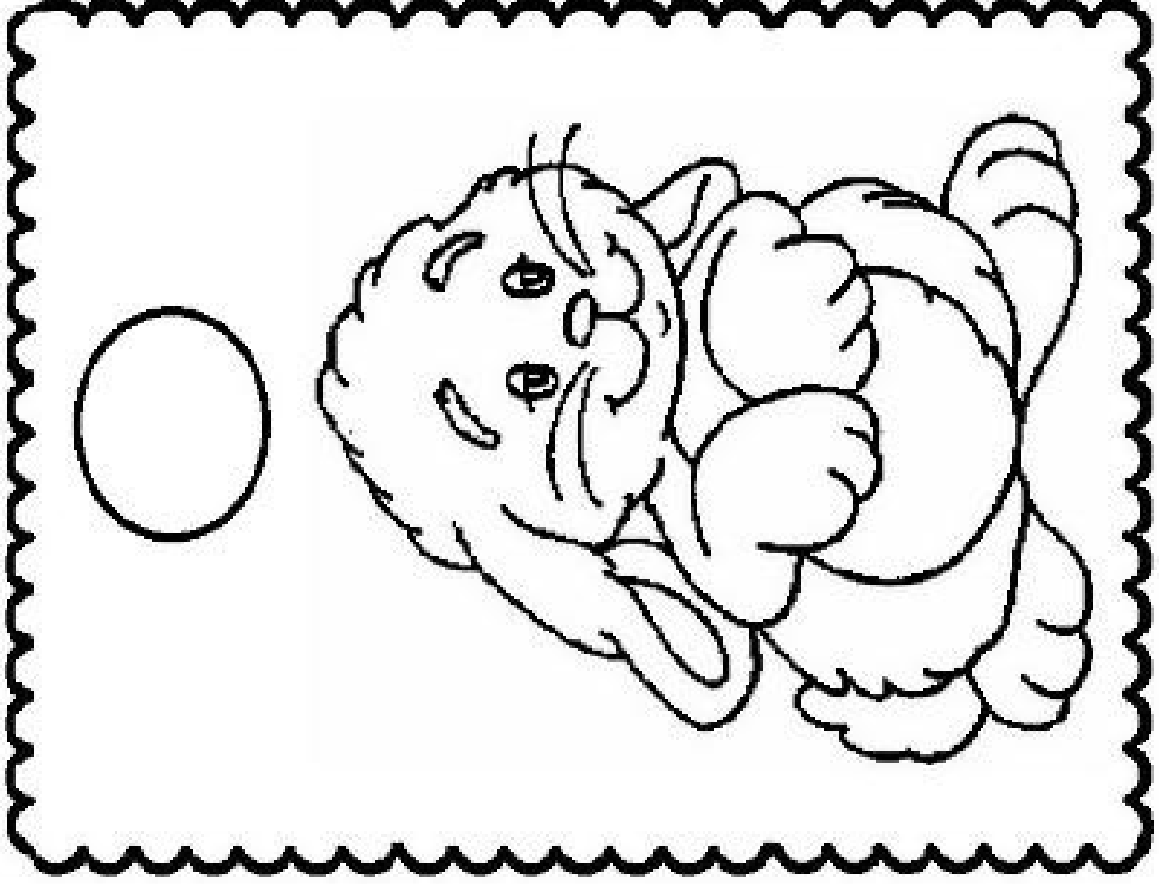

© Sayfalarda kullanılan resimler yerli ve yabancı çeşitli internet sitelerinden alınmış yapılmıştır. ÜCRETSİZ SAYFALAR