

Desenlerini çiz.

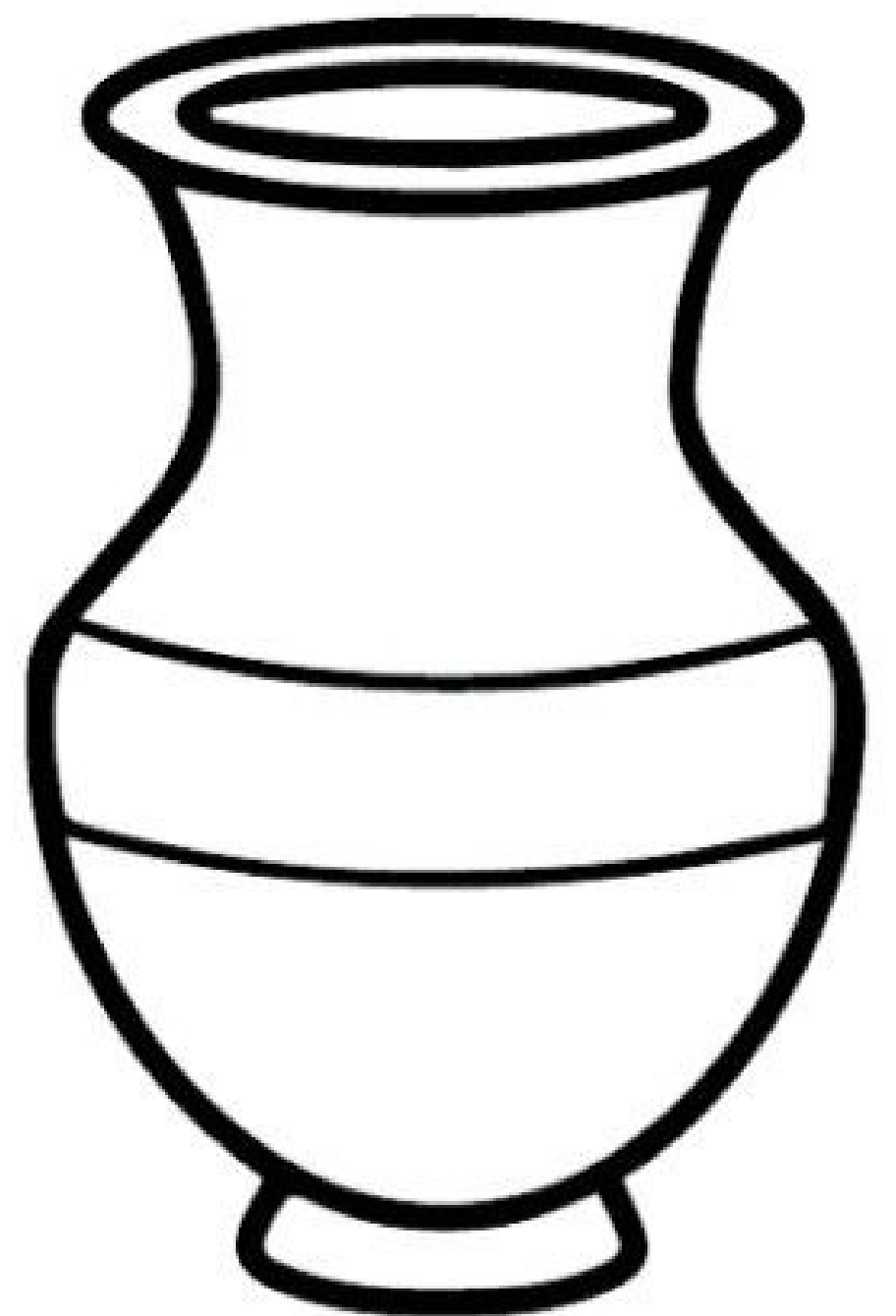

Vazoların diğer yarısını çiz.

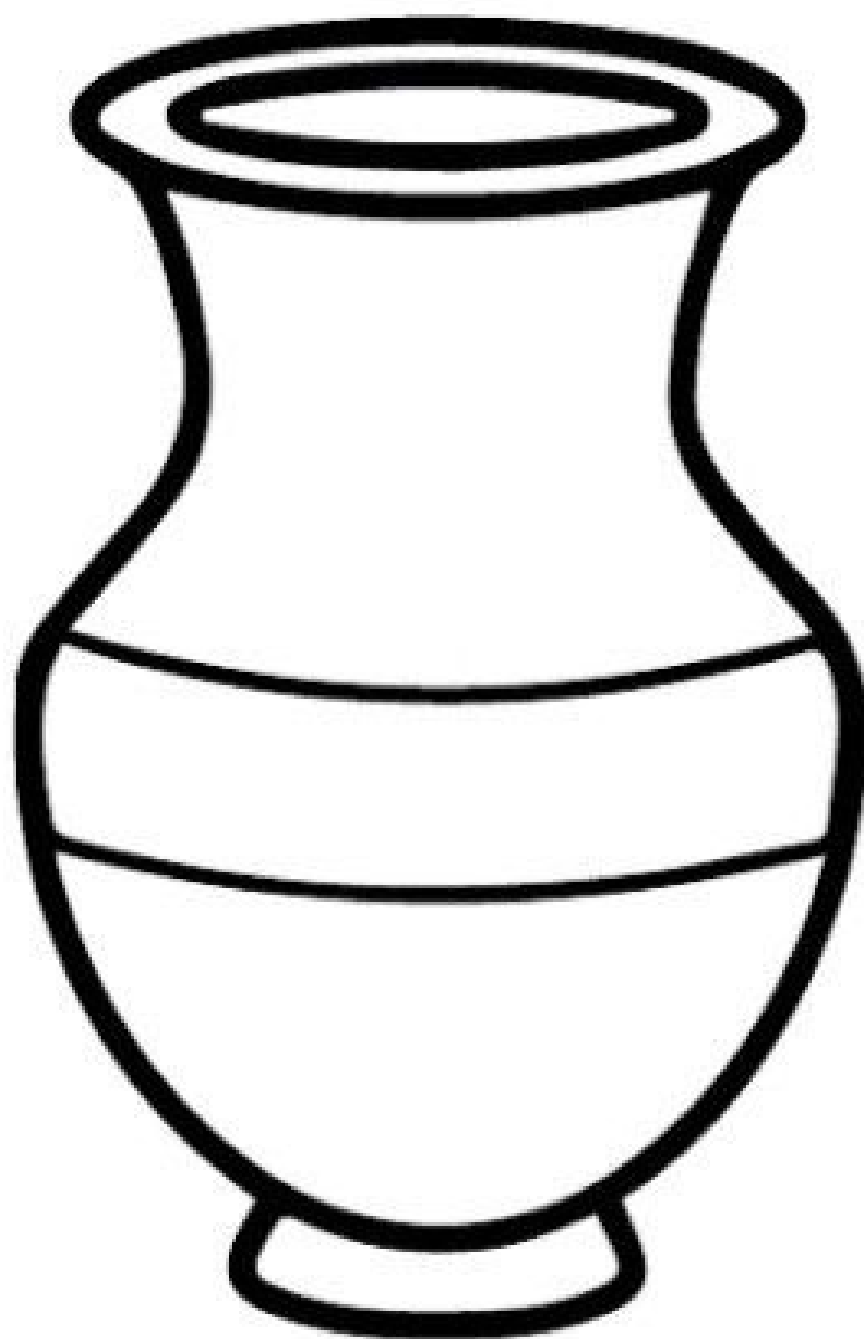

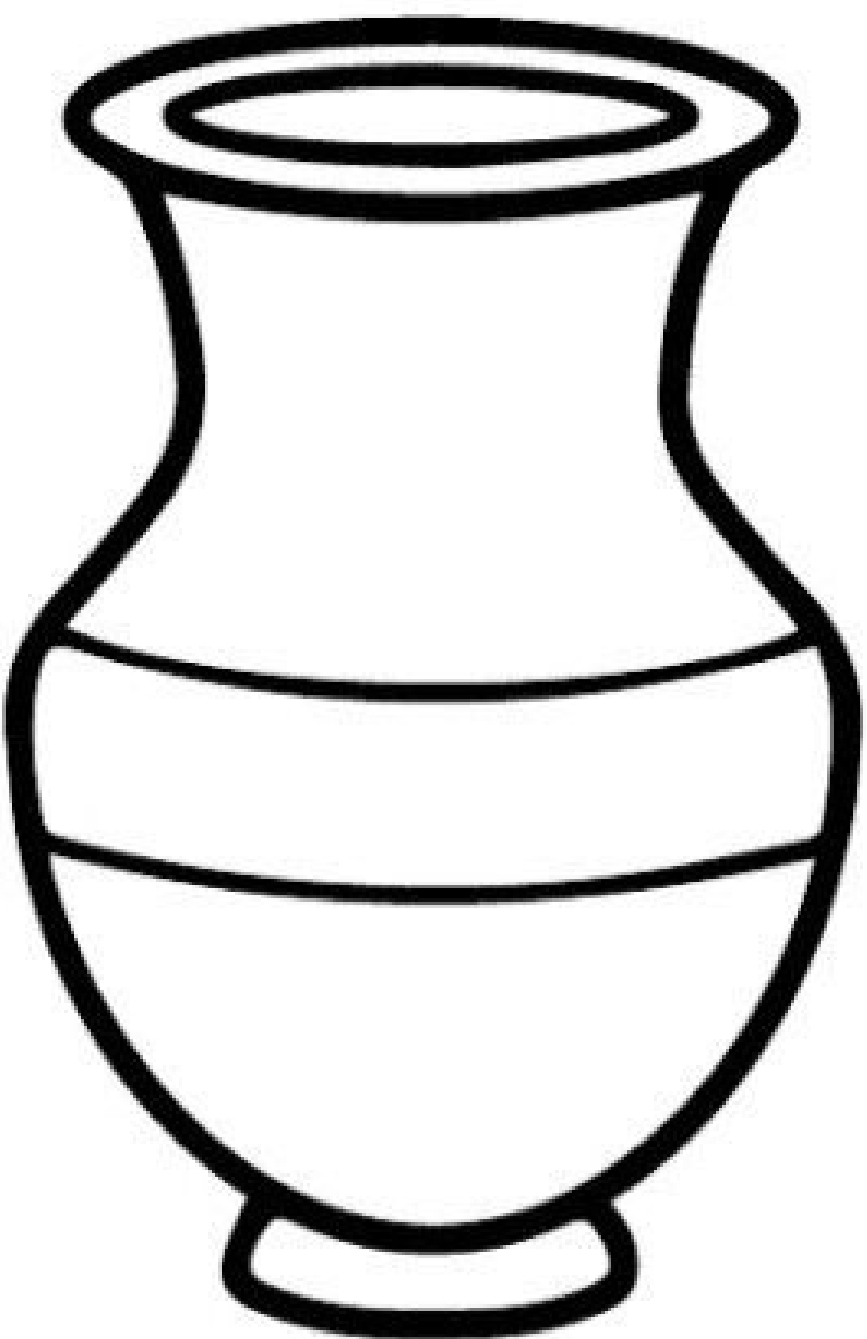
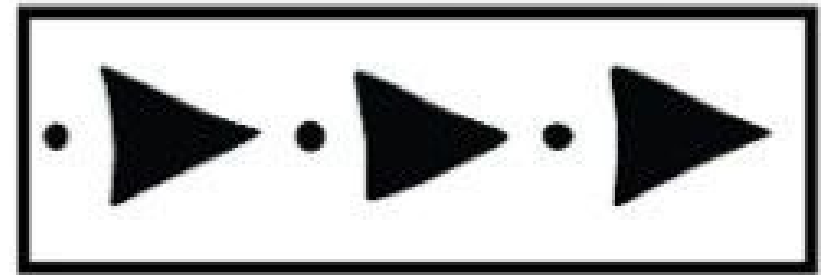
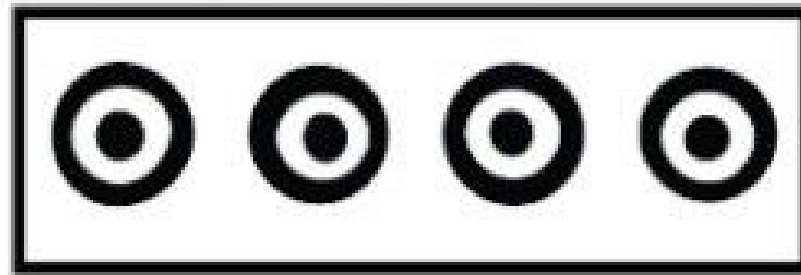
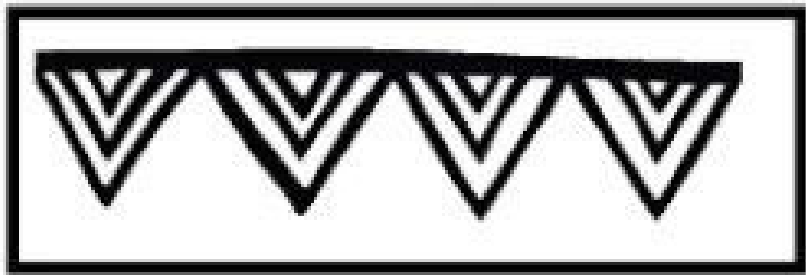
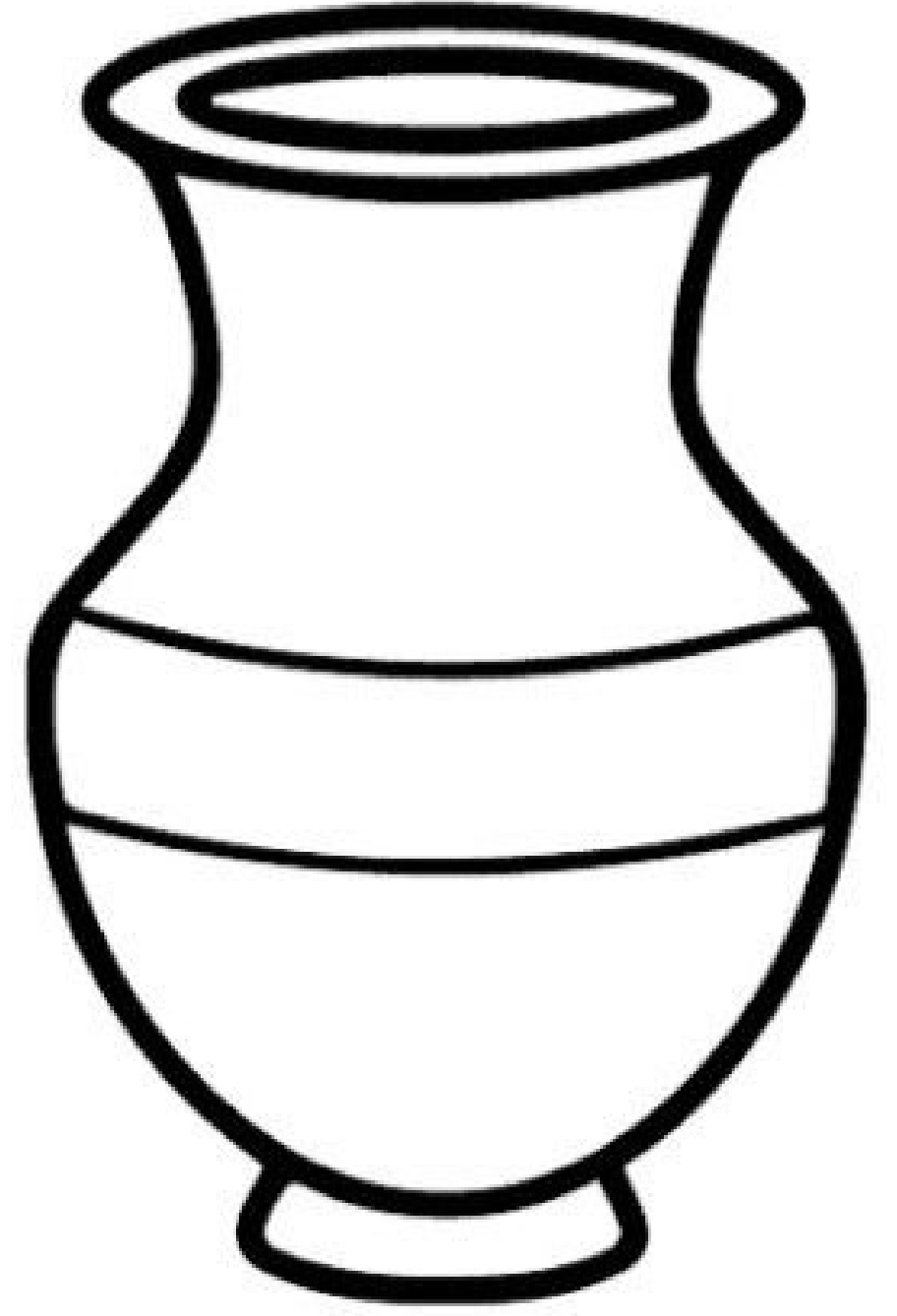
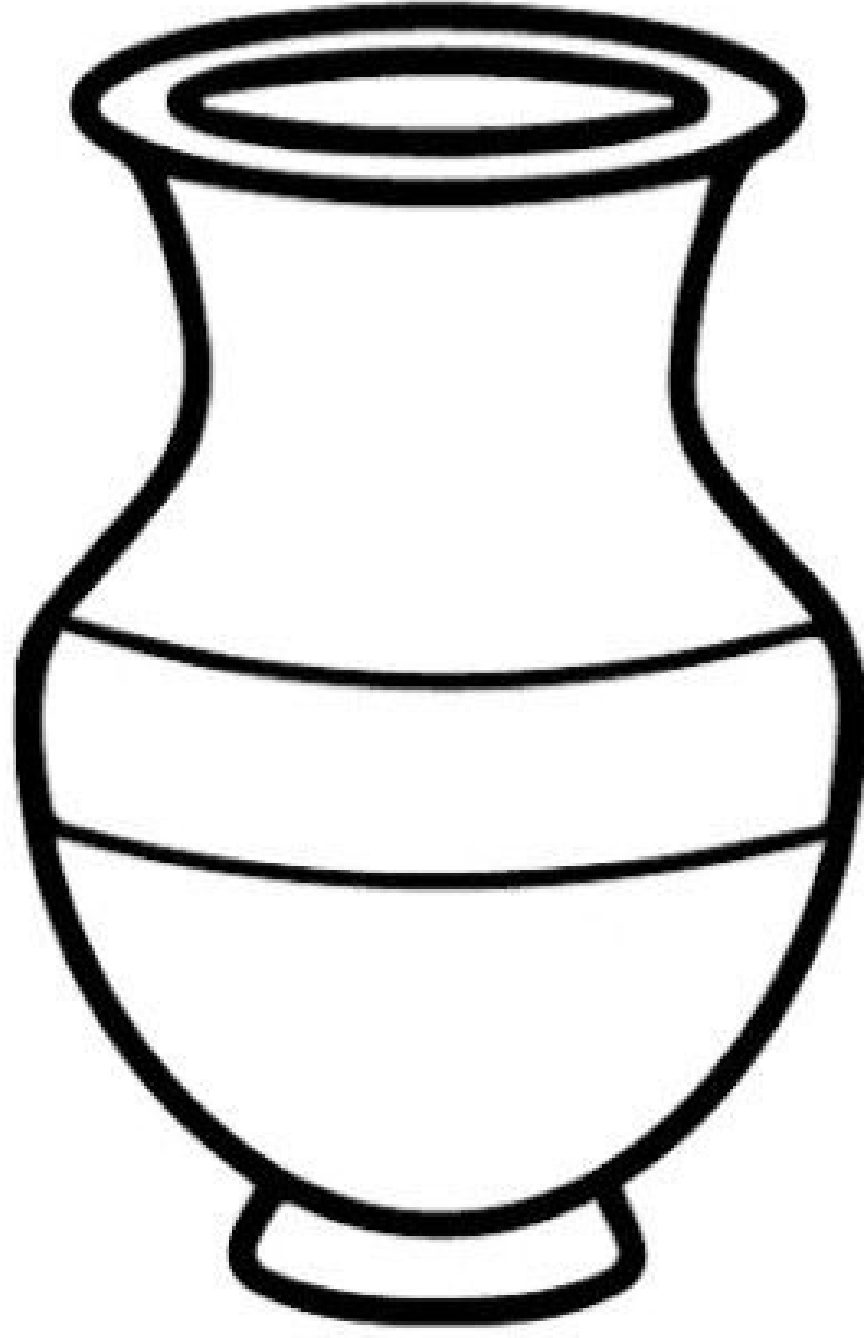
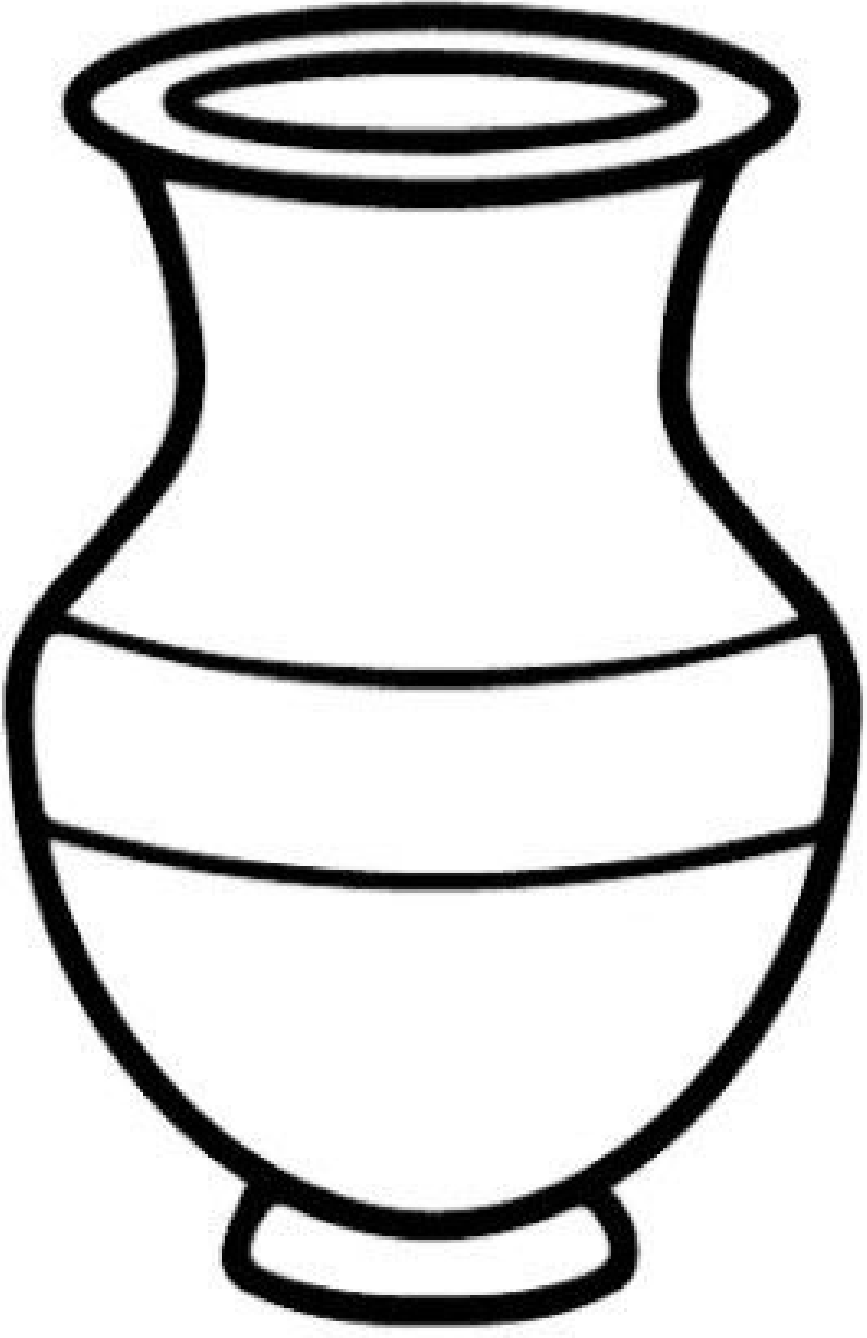
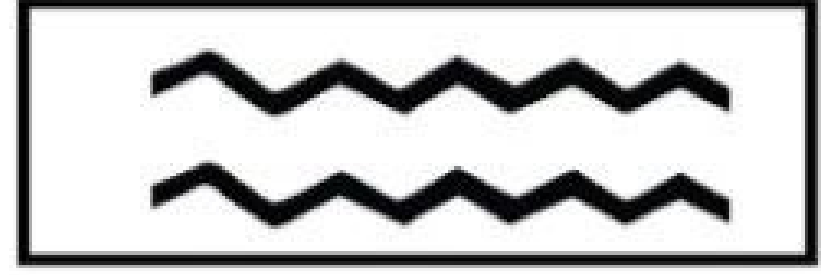
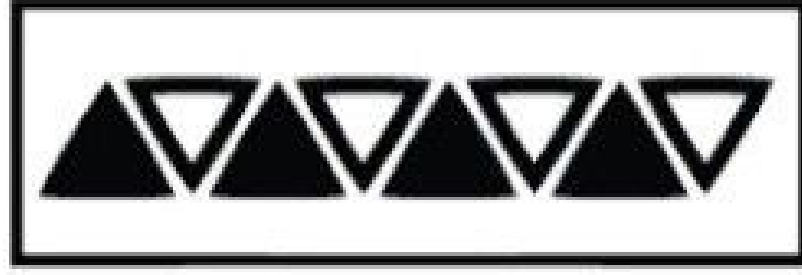
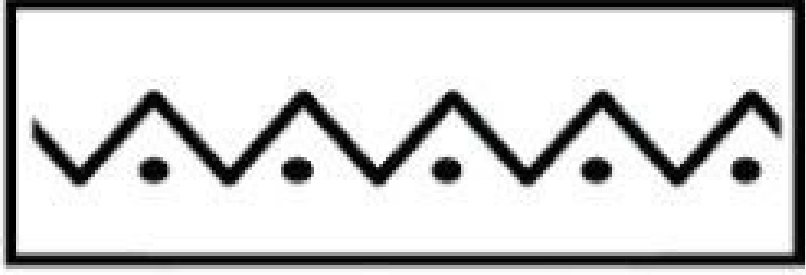
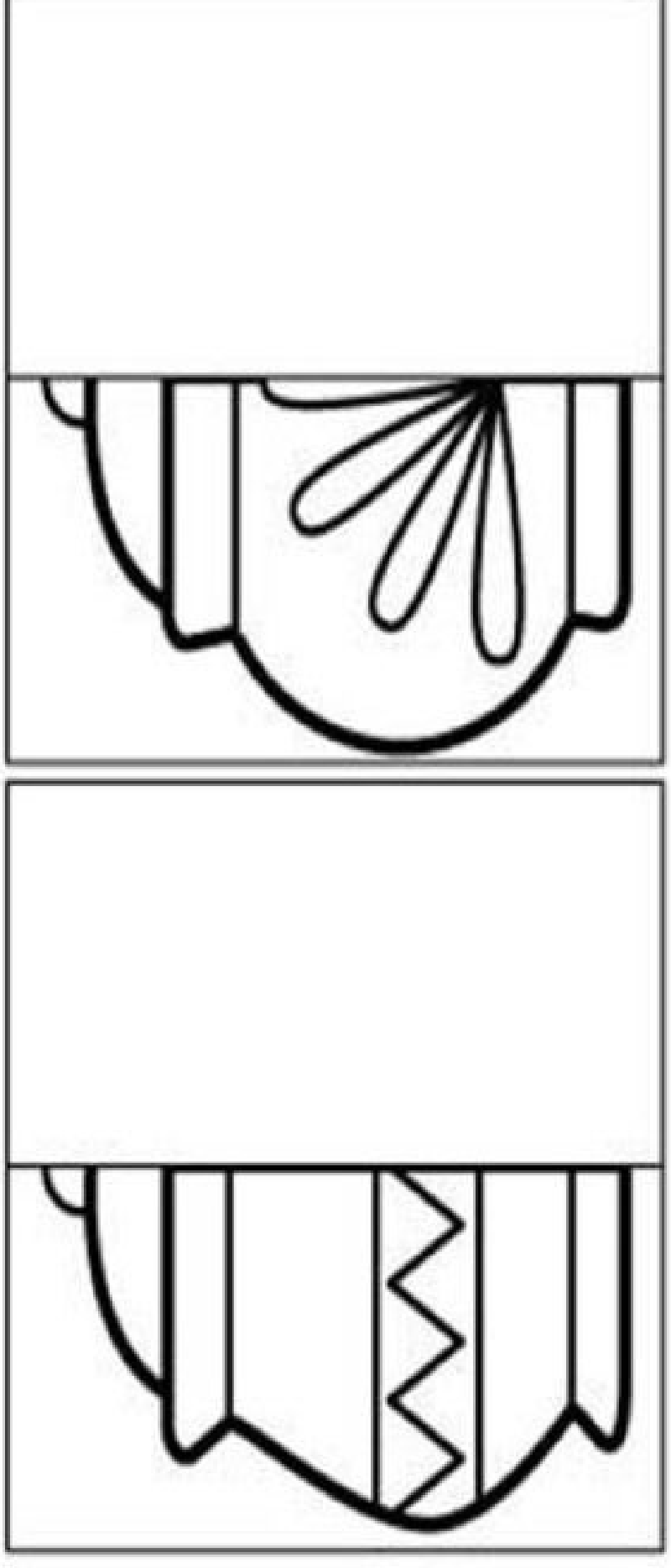
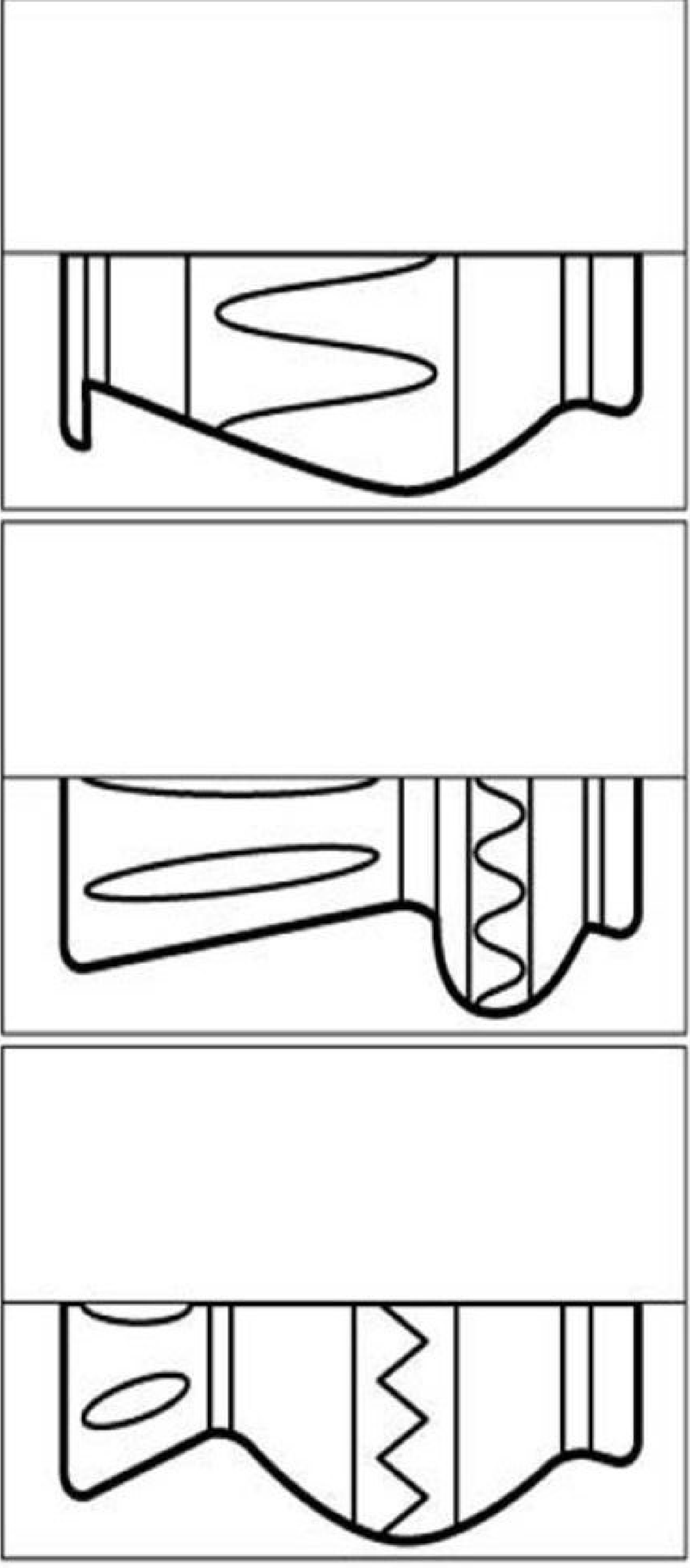

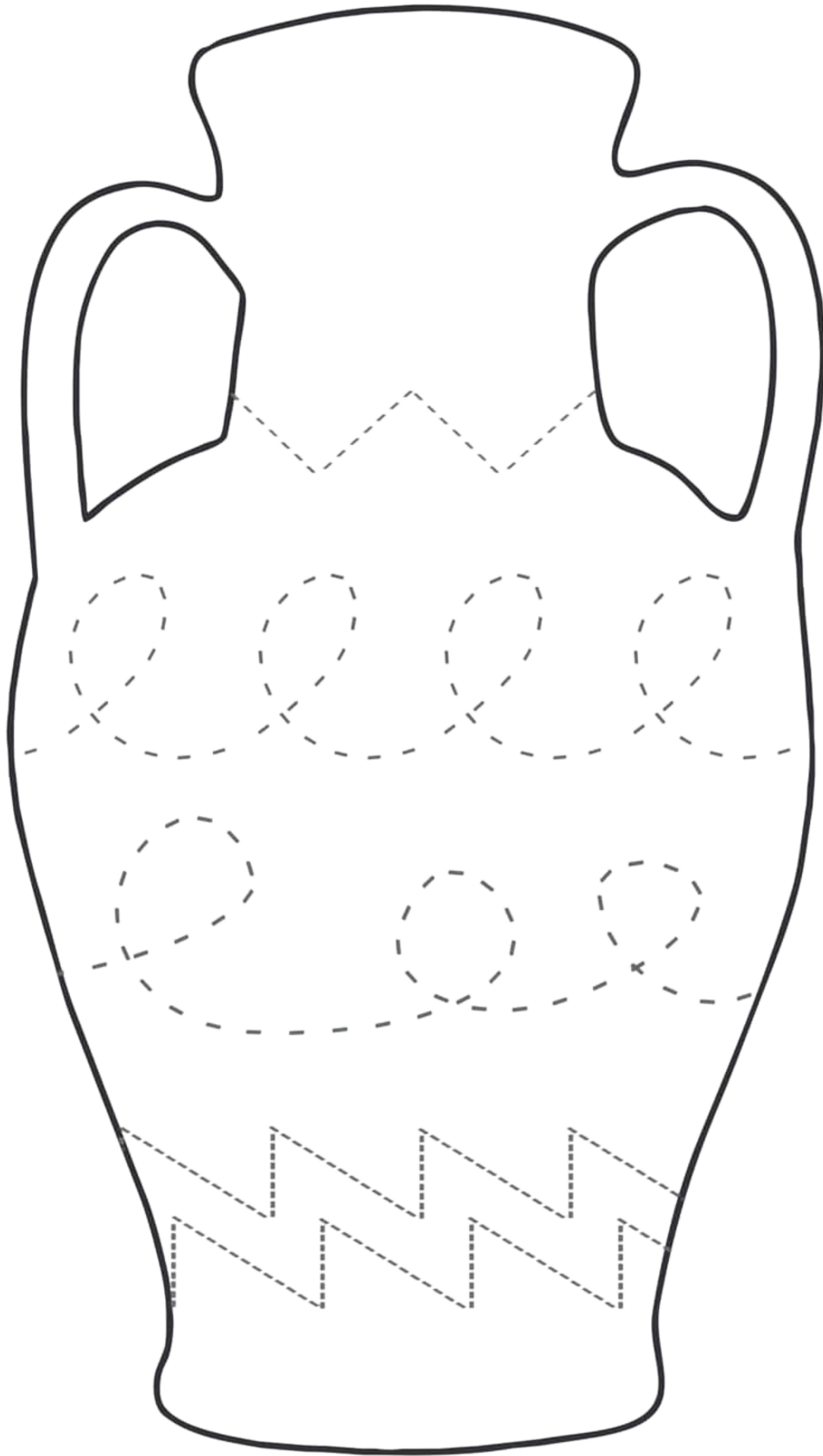

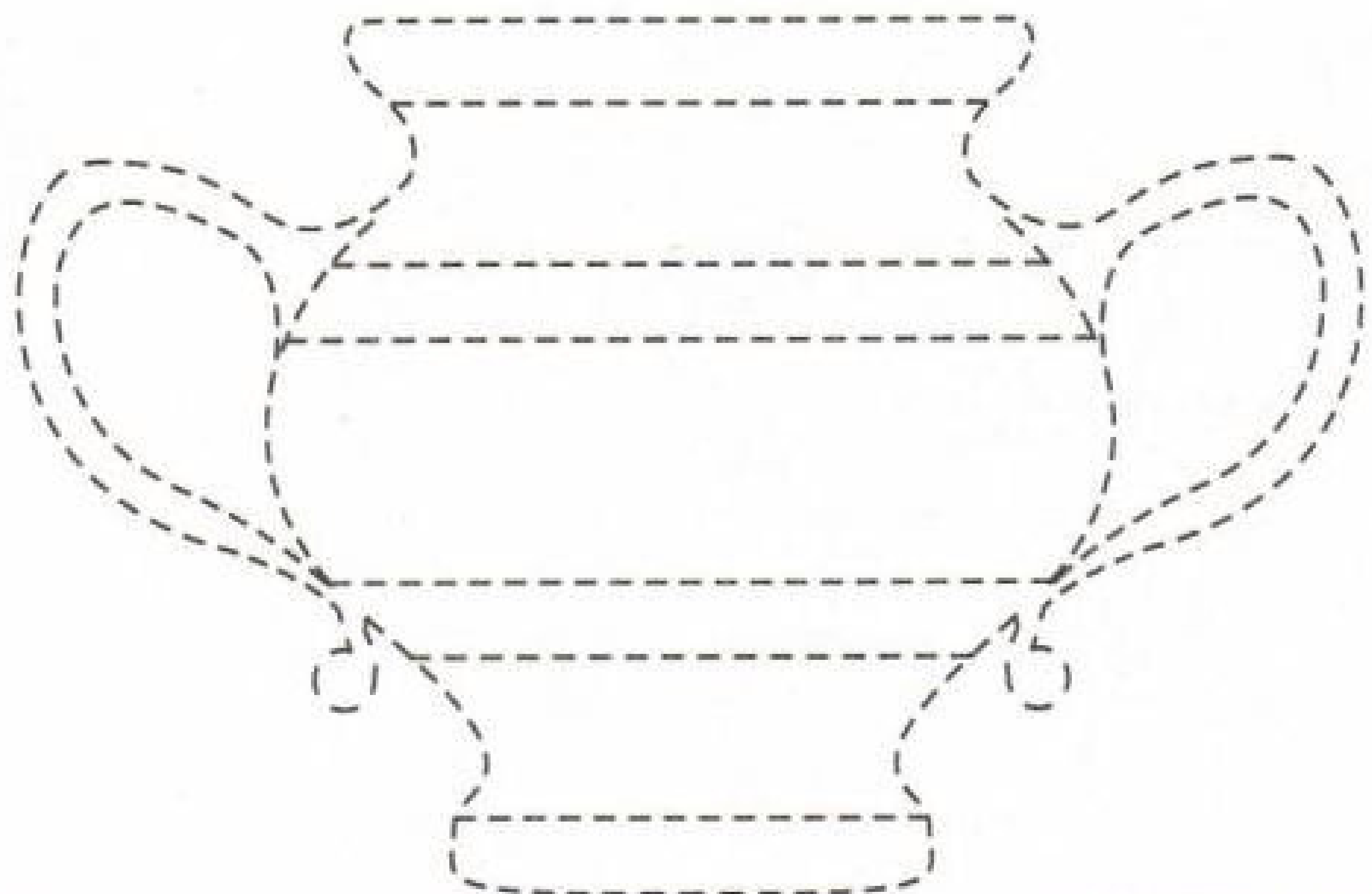
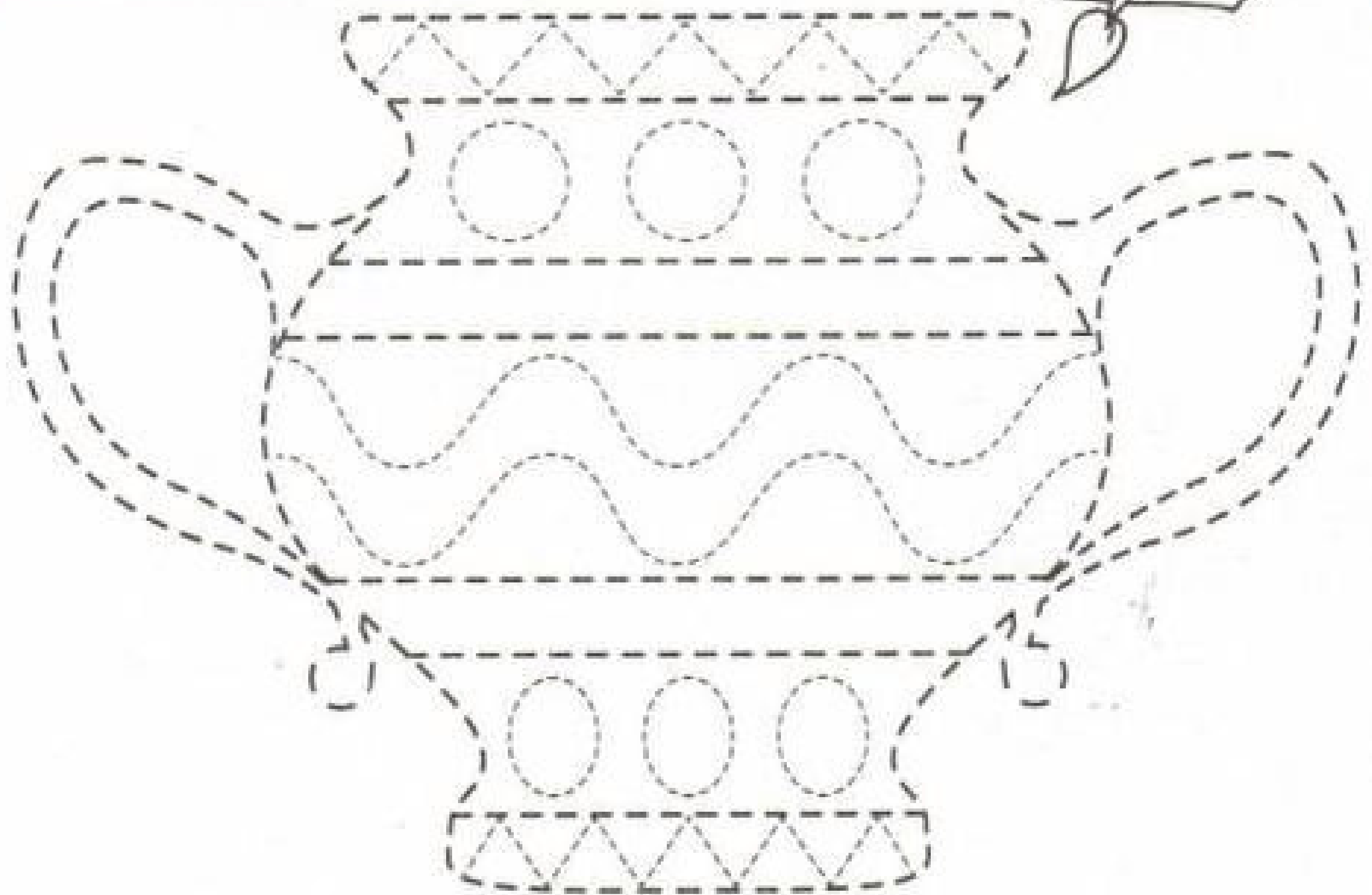

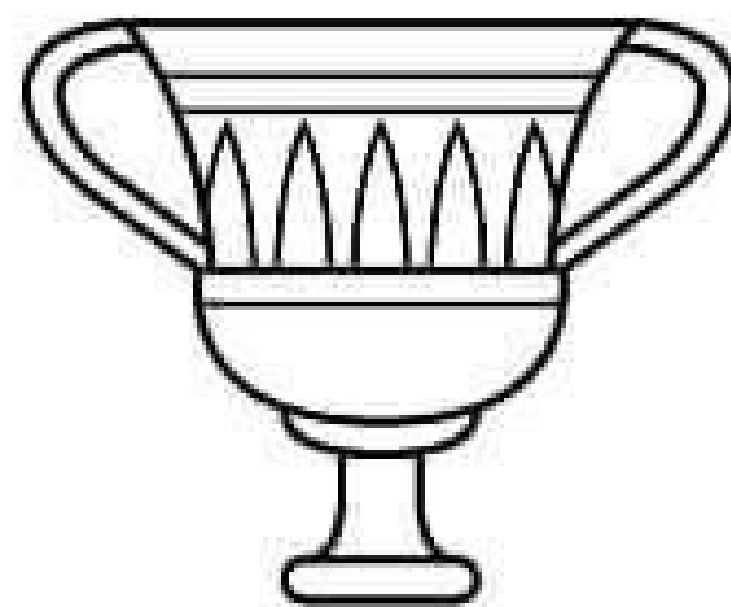
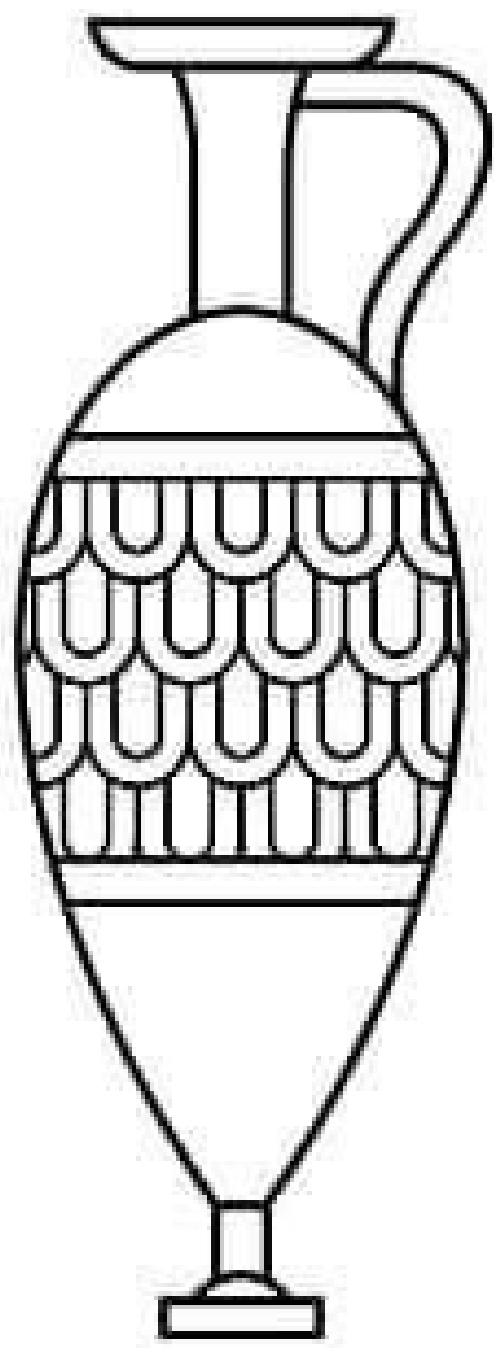
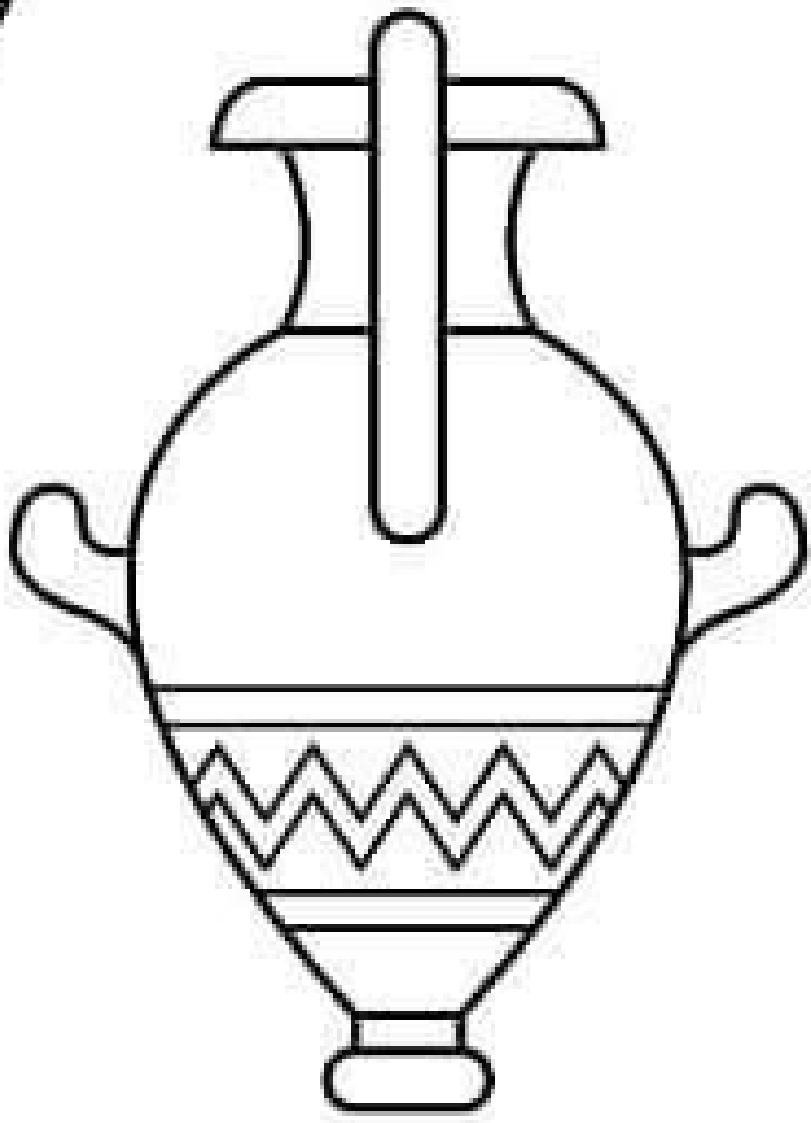
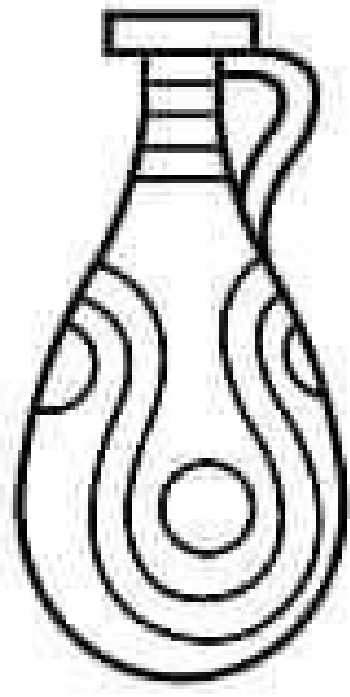
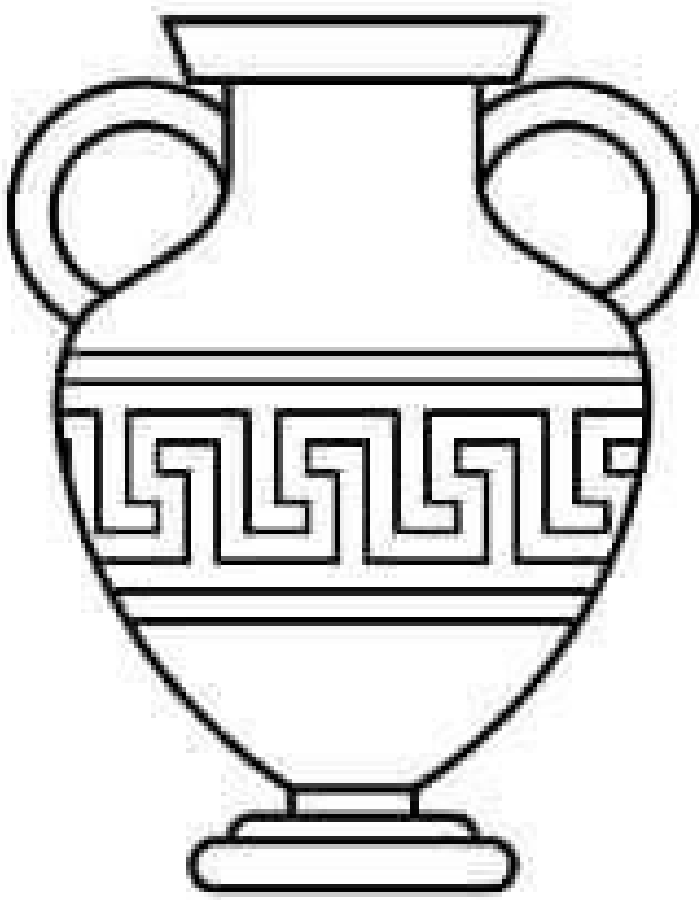
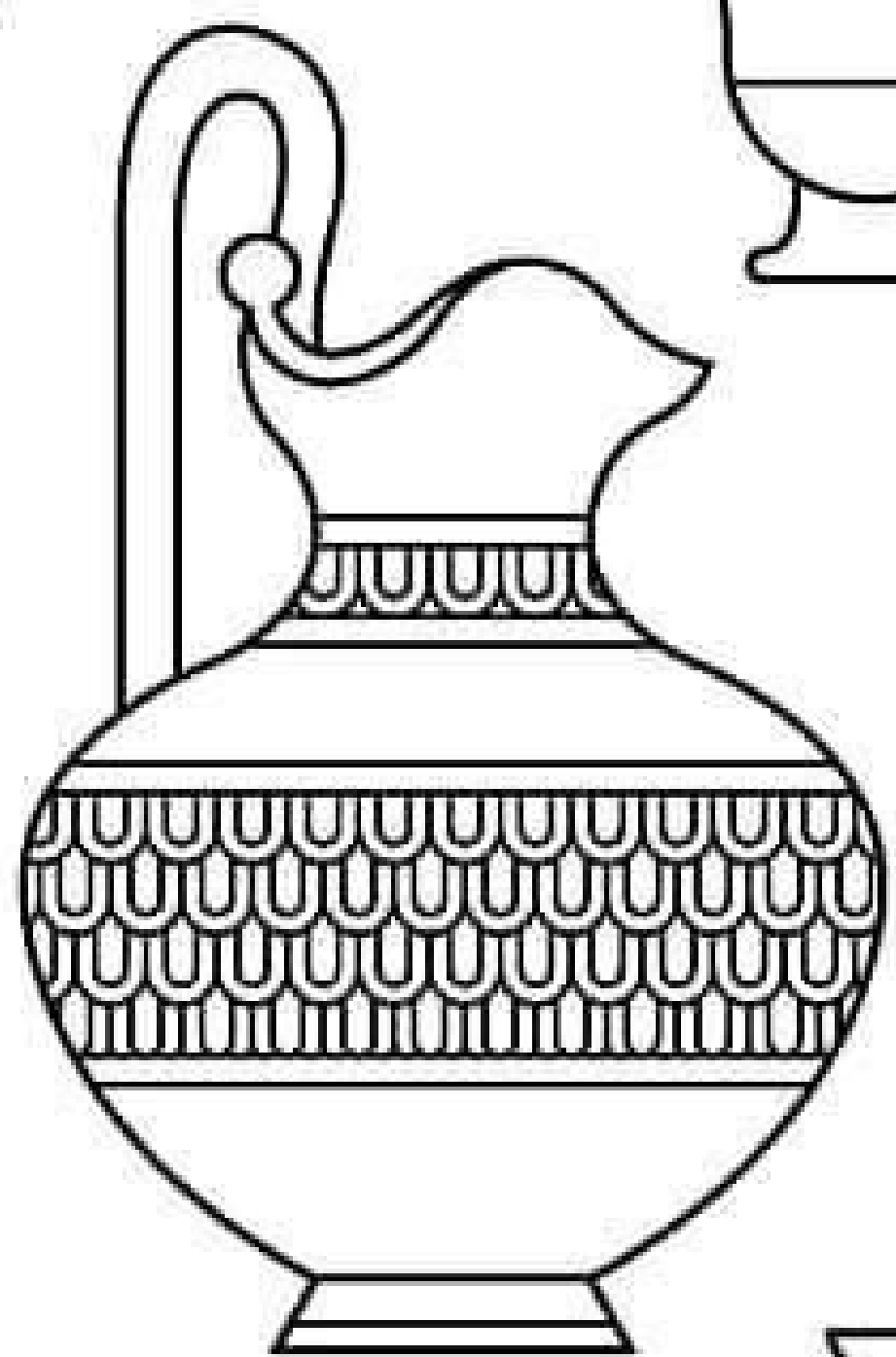
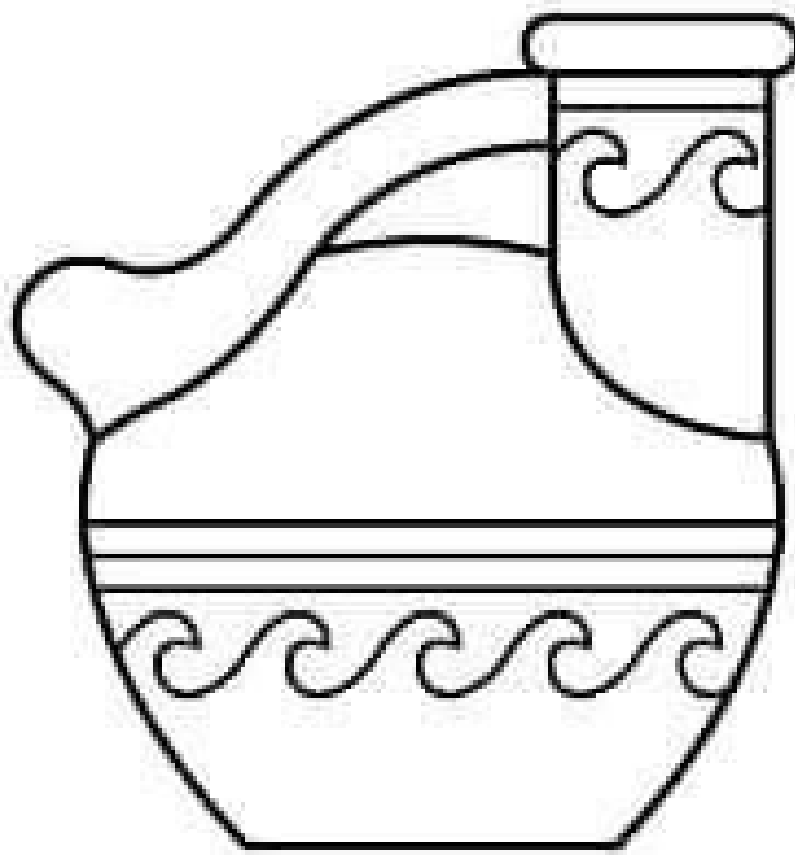
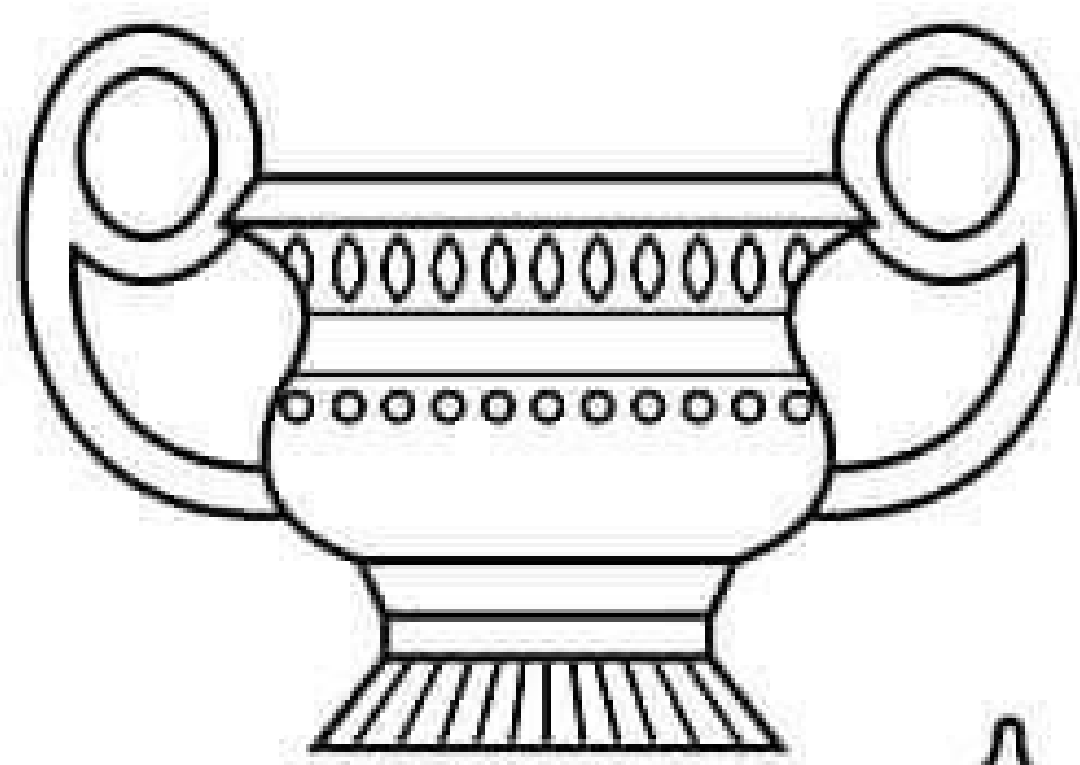
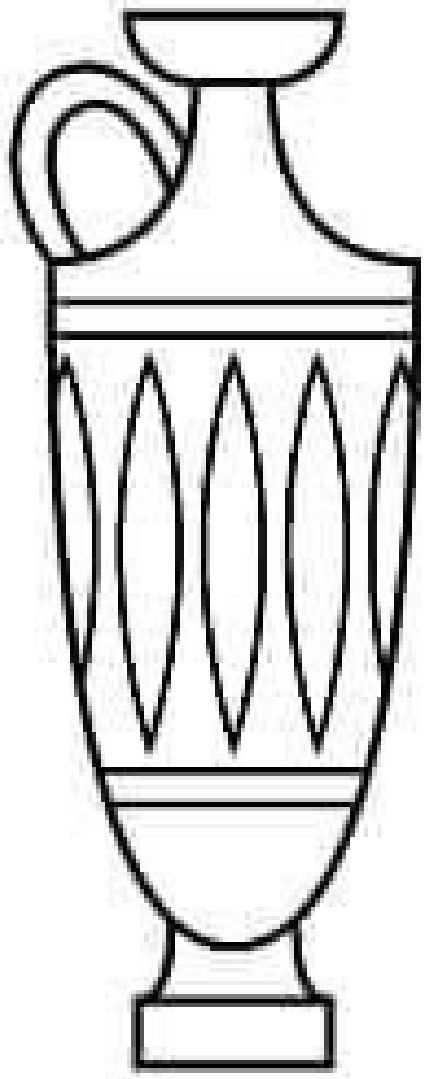

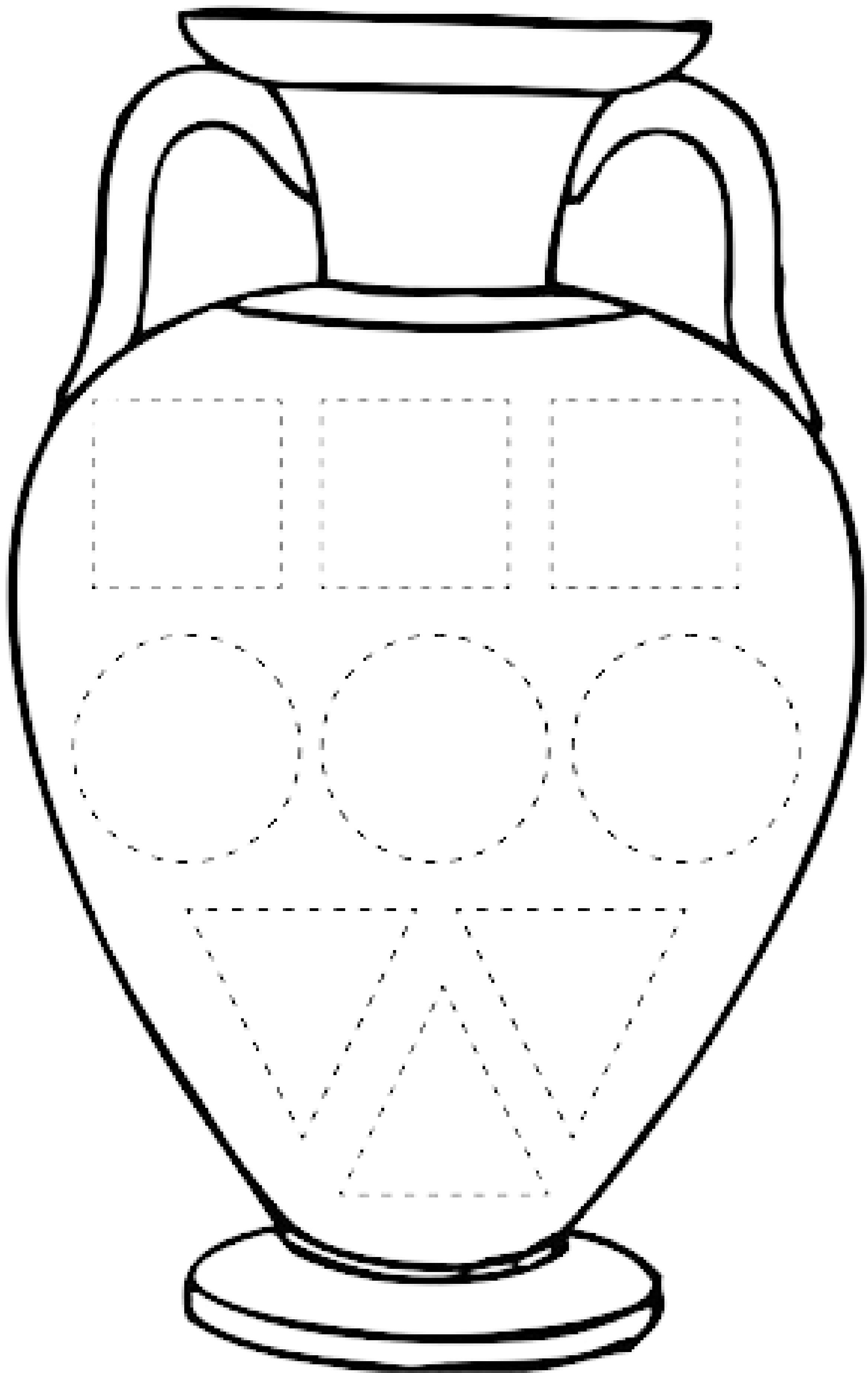

Her sırada farklı olanı bulup boyar mısın?

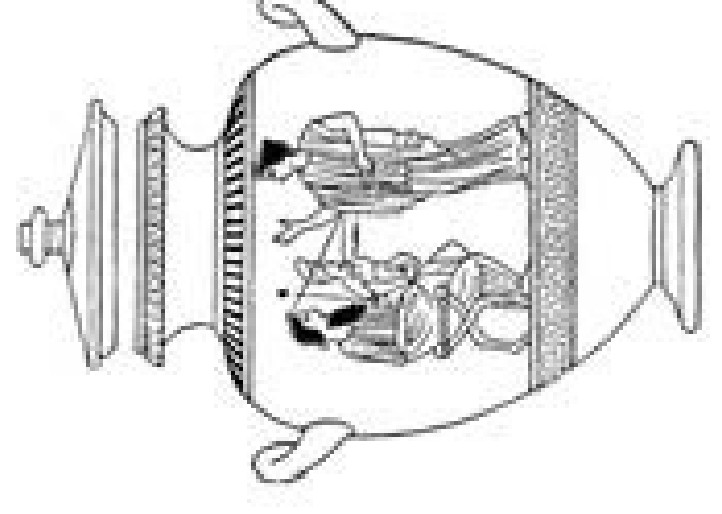
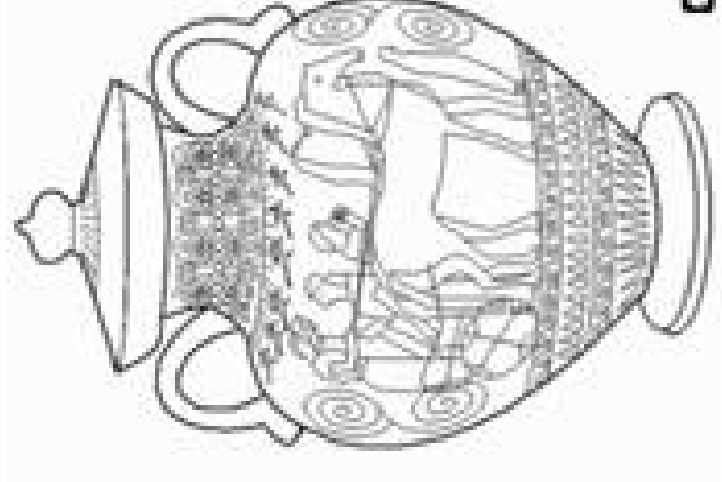
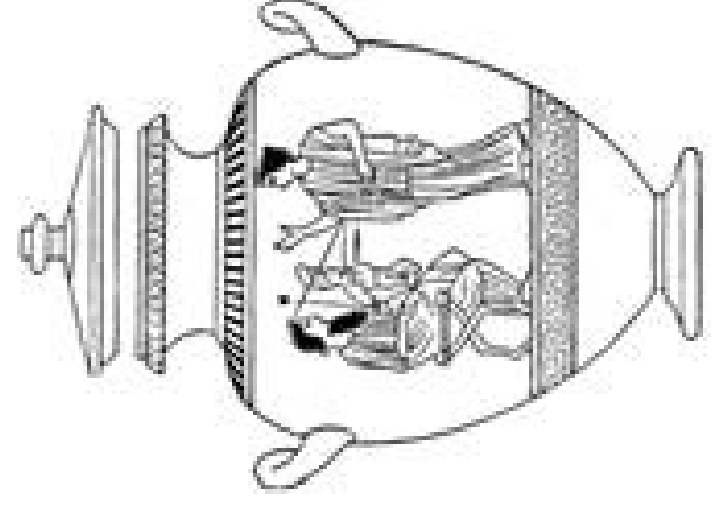
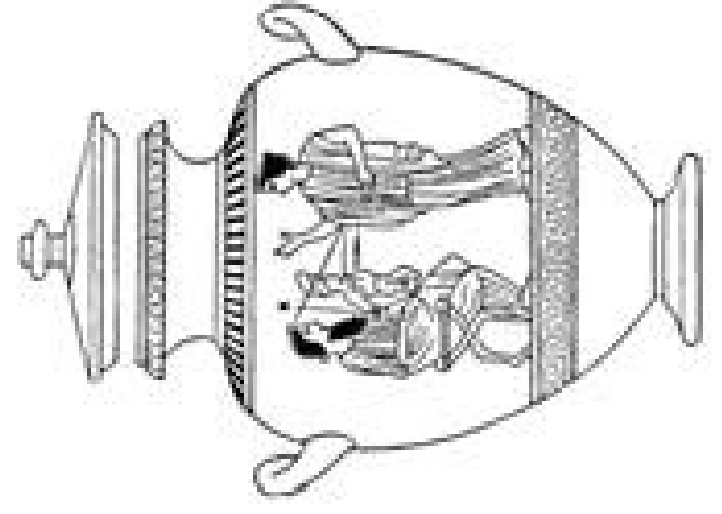
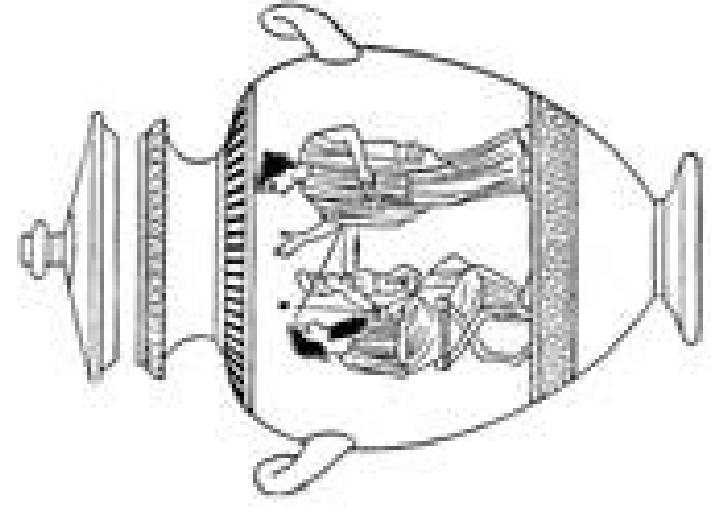
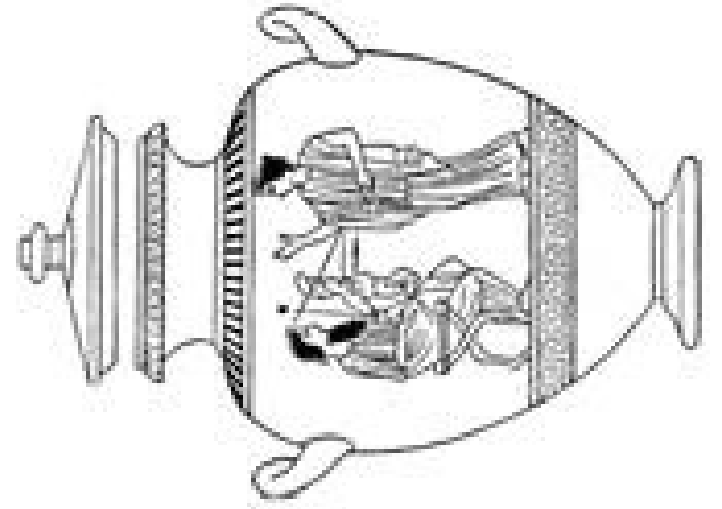
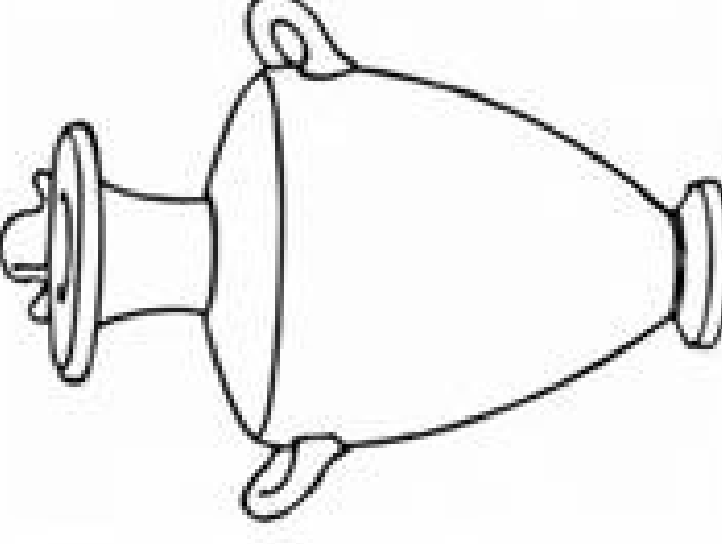
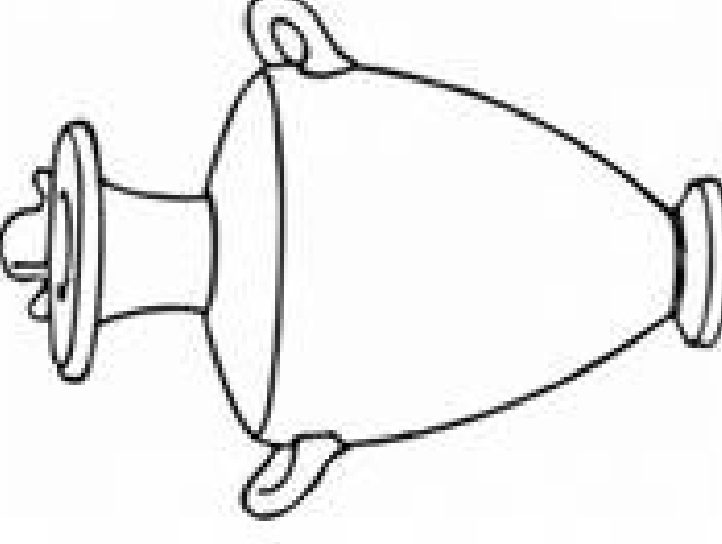
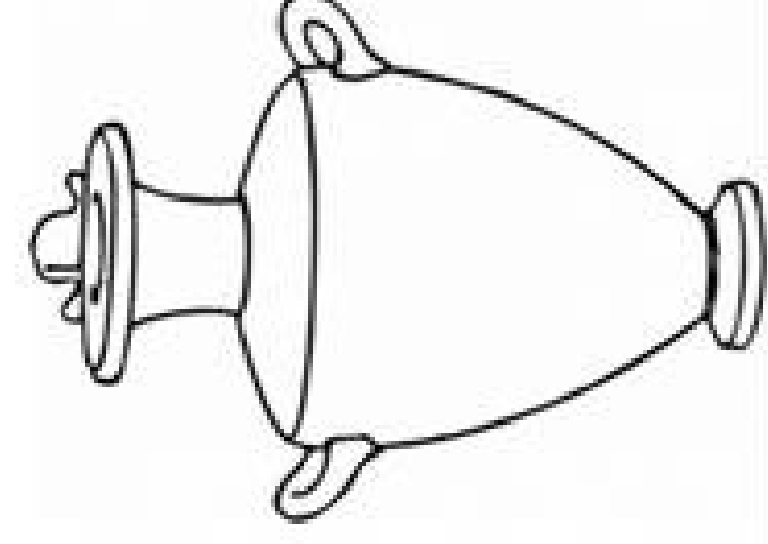
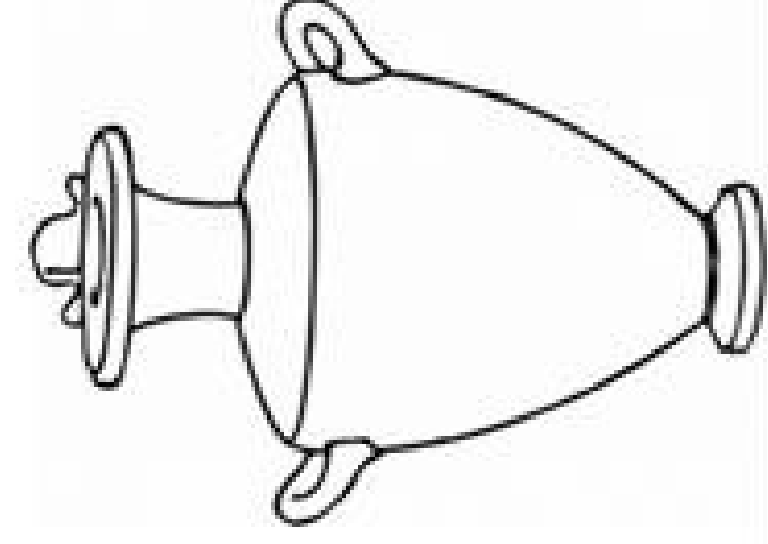
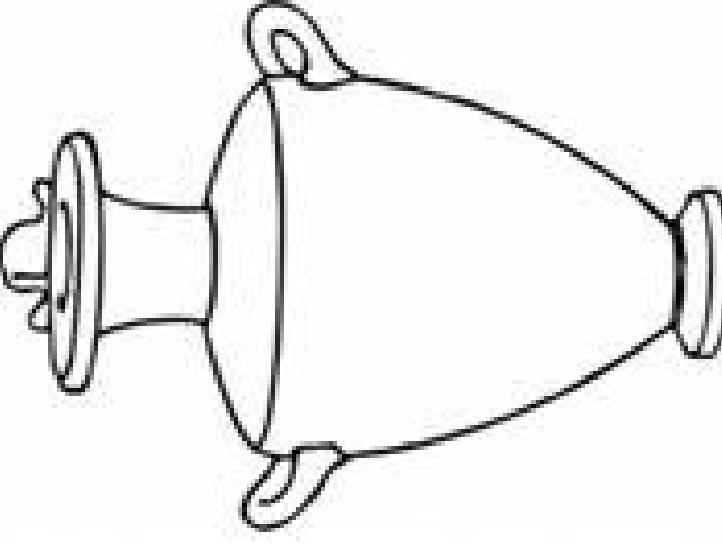
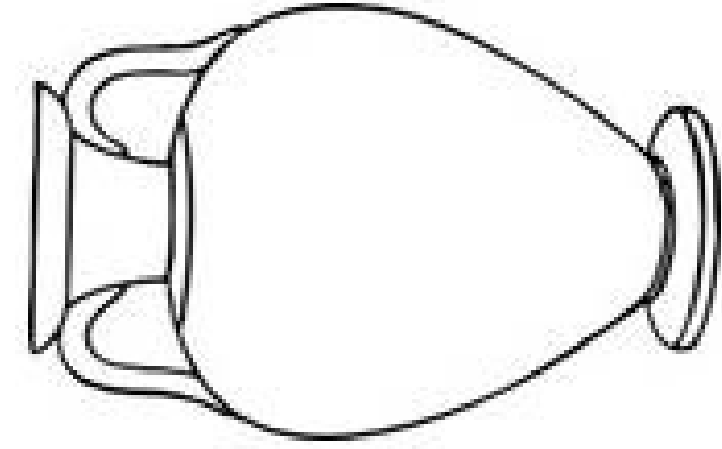
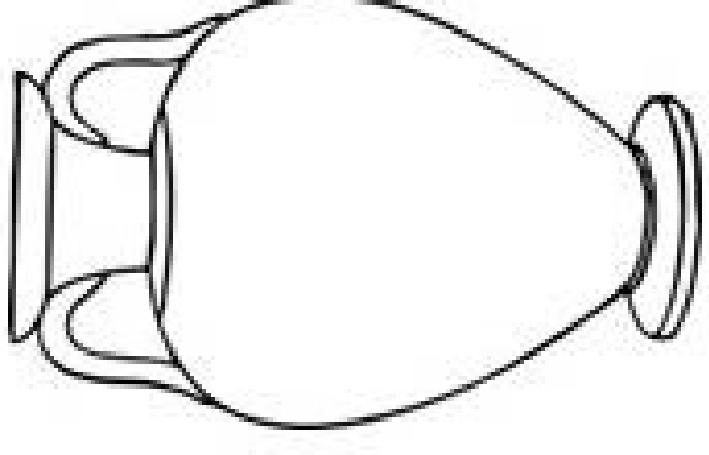
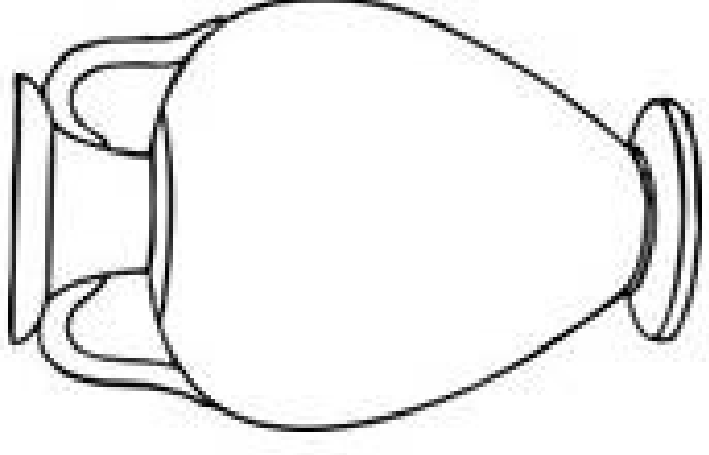
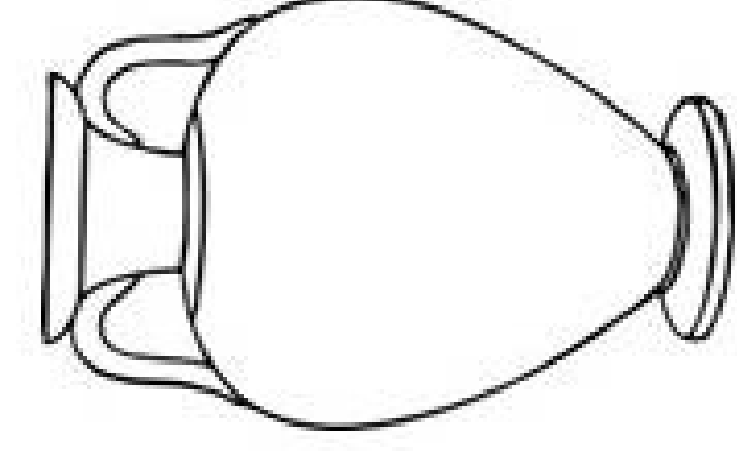
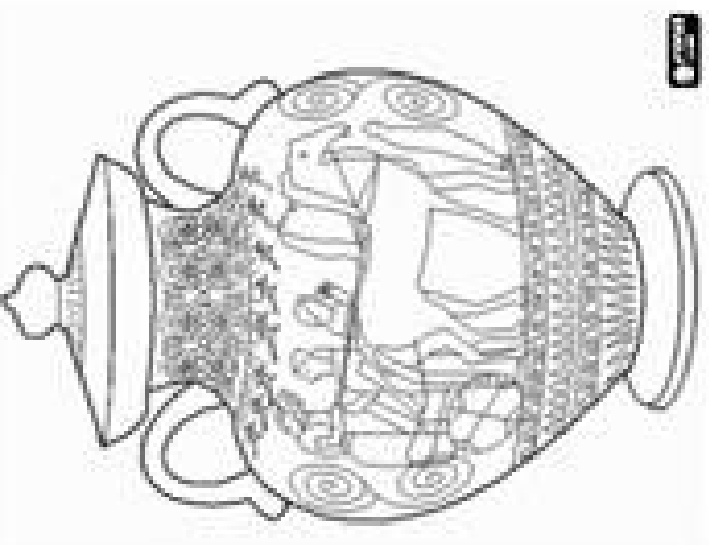
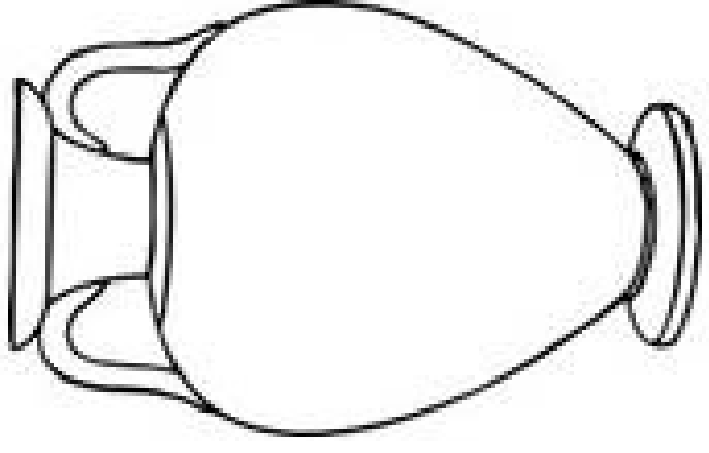
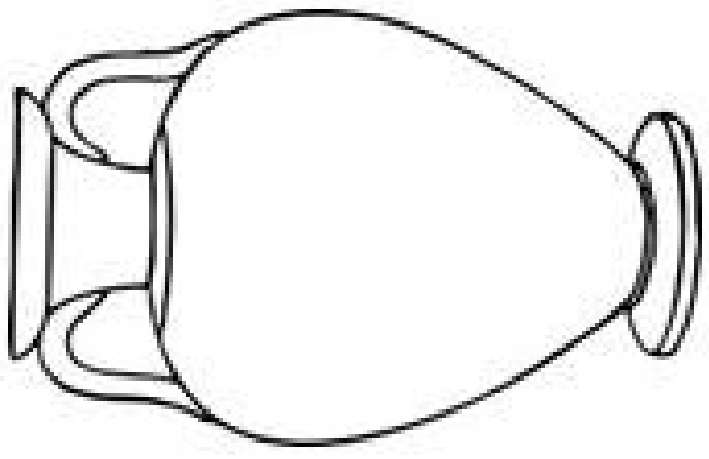



Her sıradaki vazoları sayarak karşıdaki karenin içine kaç tane olduğunu yazar mısın?

