

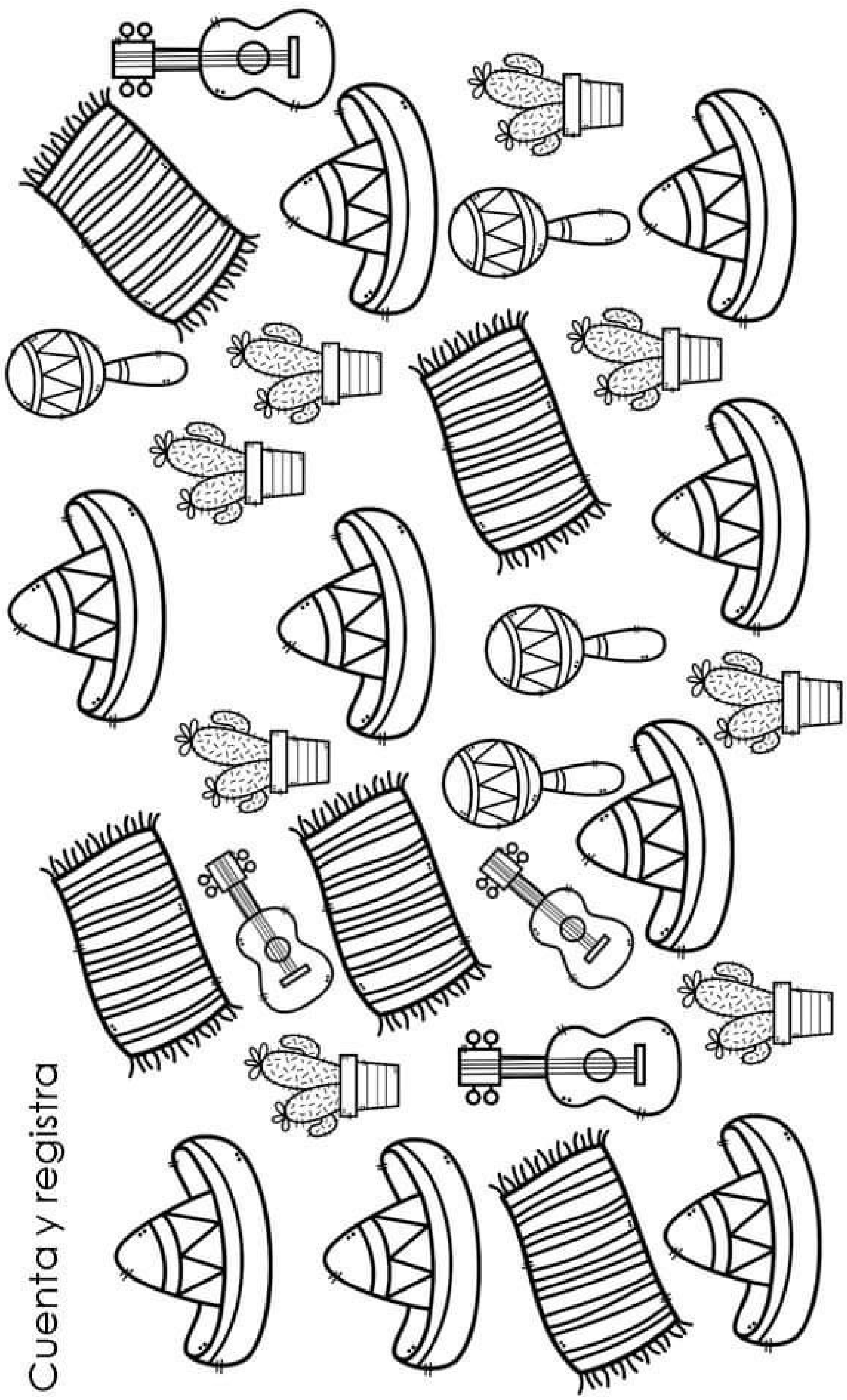

Cuenta y registra

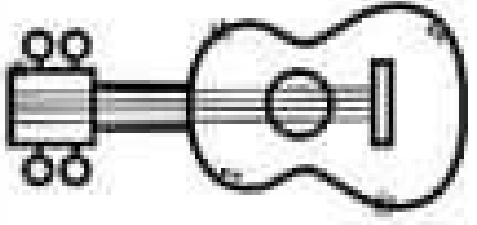

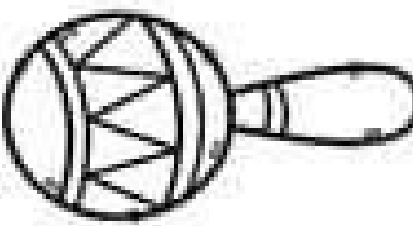

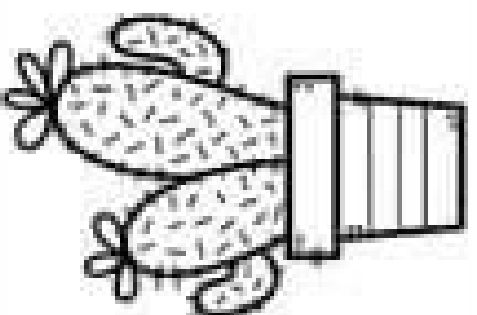

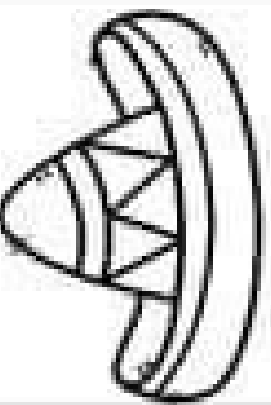

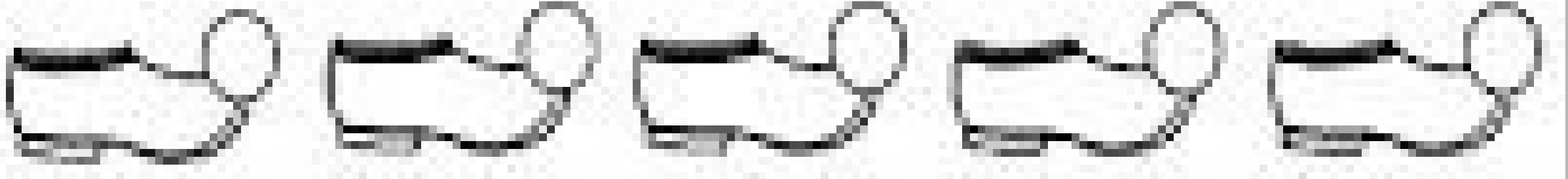
Baştaki sayı kadar görsel boyar mısın?

2

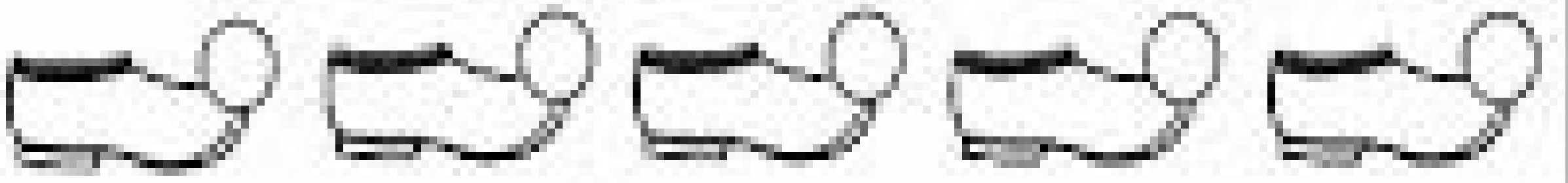

0



5

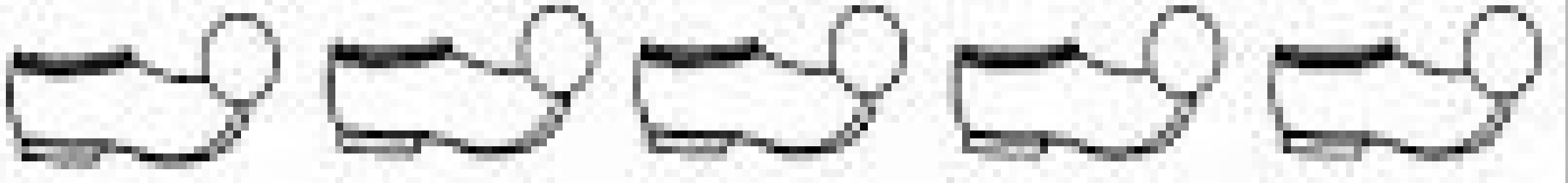

1



4

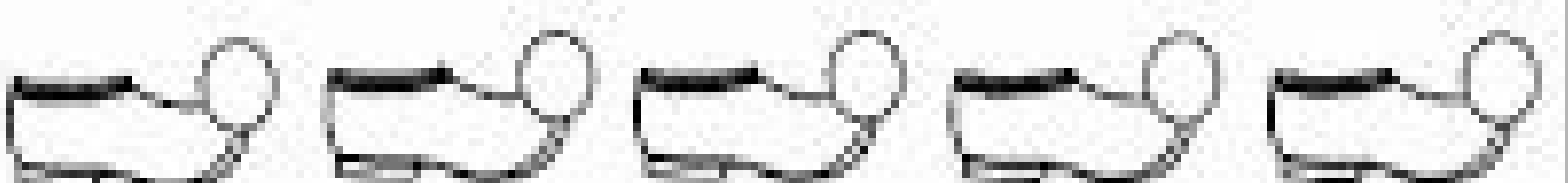

3

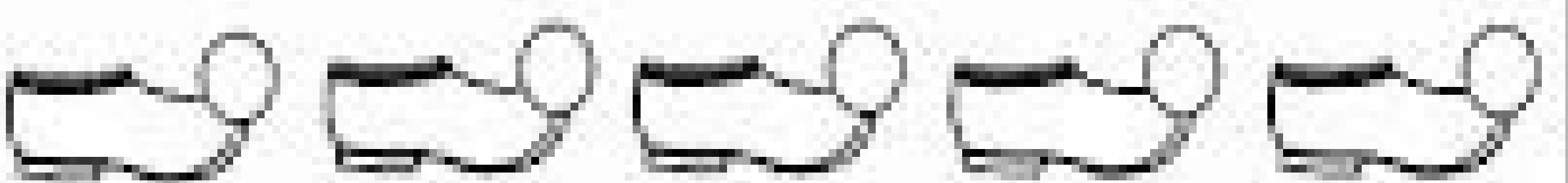

Baştaki sayı kadar görsel boyar mısın?

7

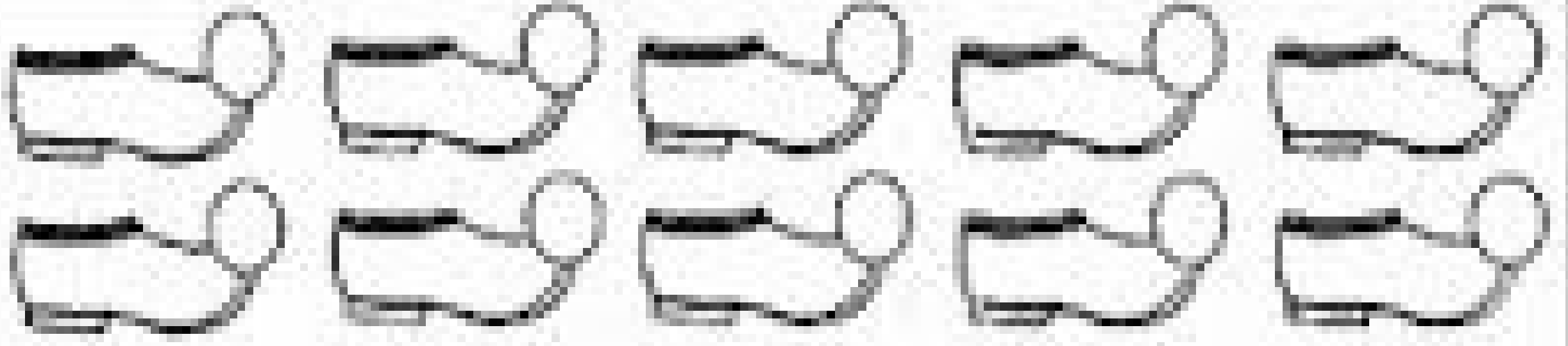

10

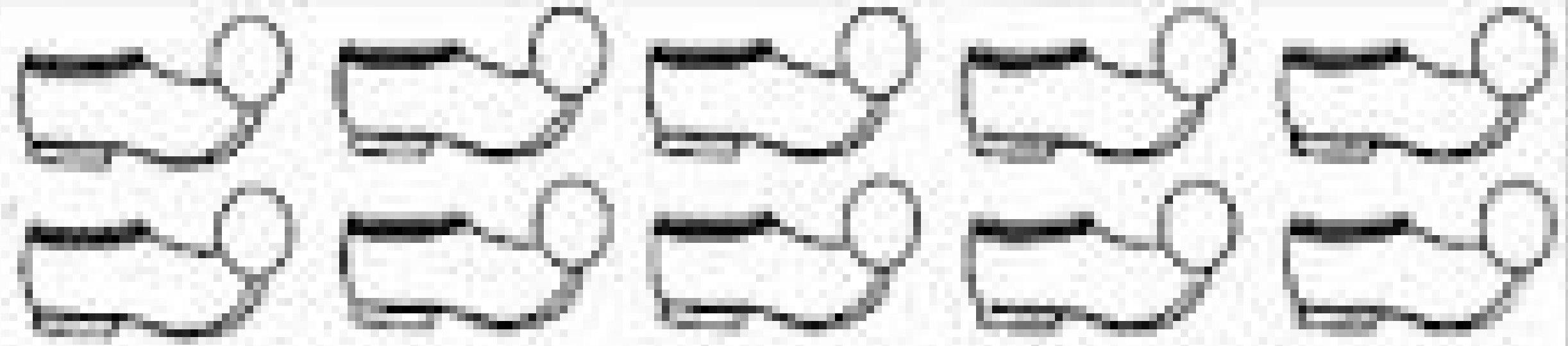

6



9

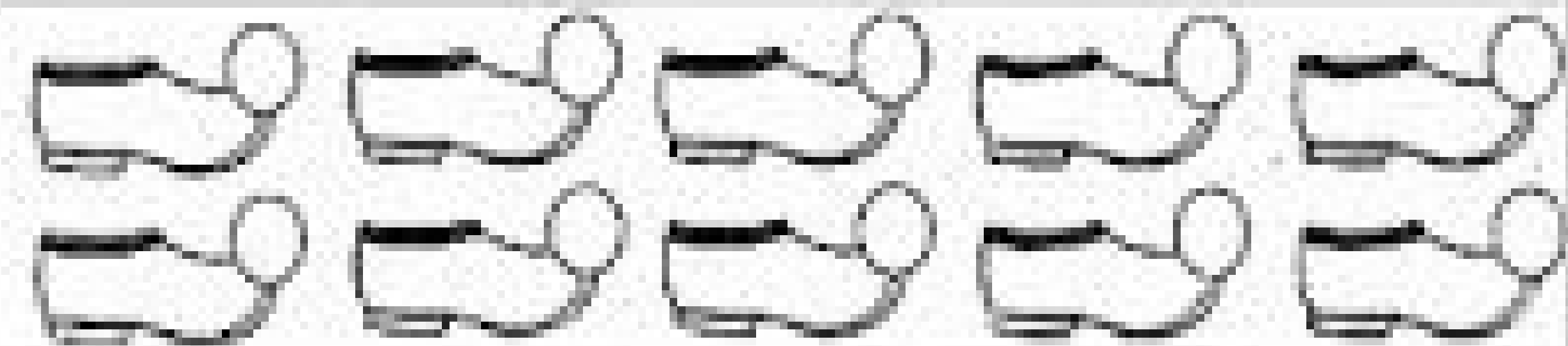

5



8

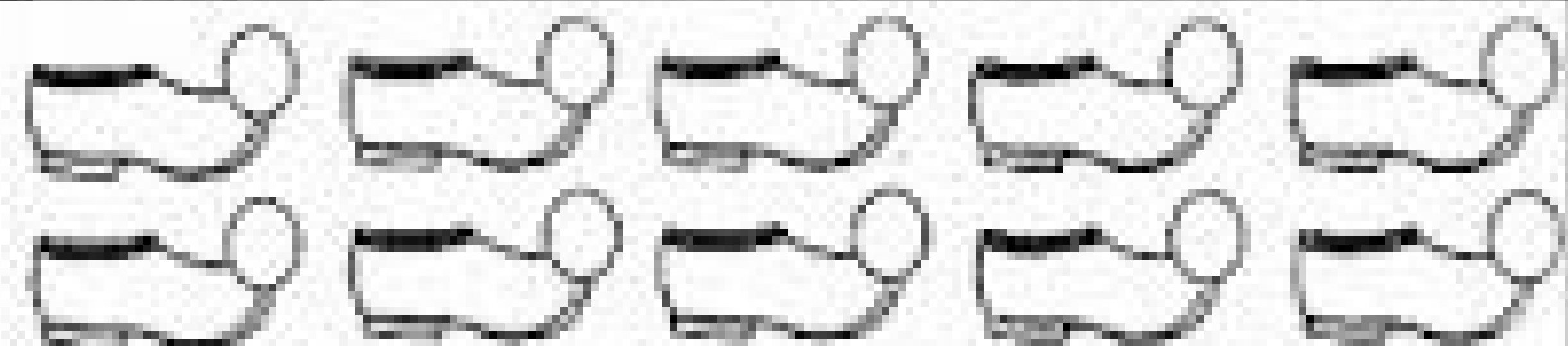





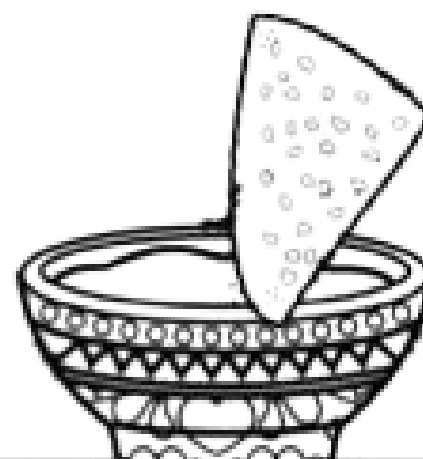

# MÉXICO LINDO Y QUERIDO



Cuenta los elementos de cada grupo, escribe la cantidad en el recuadro y al final colorea donde hay más



- 1= 
- 2= 
- 3= 
- 4= 
- 5= 
- 6= 



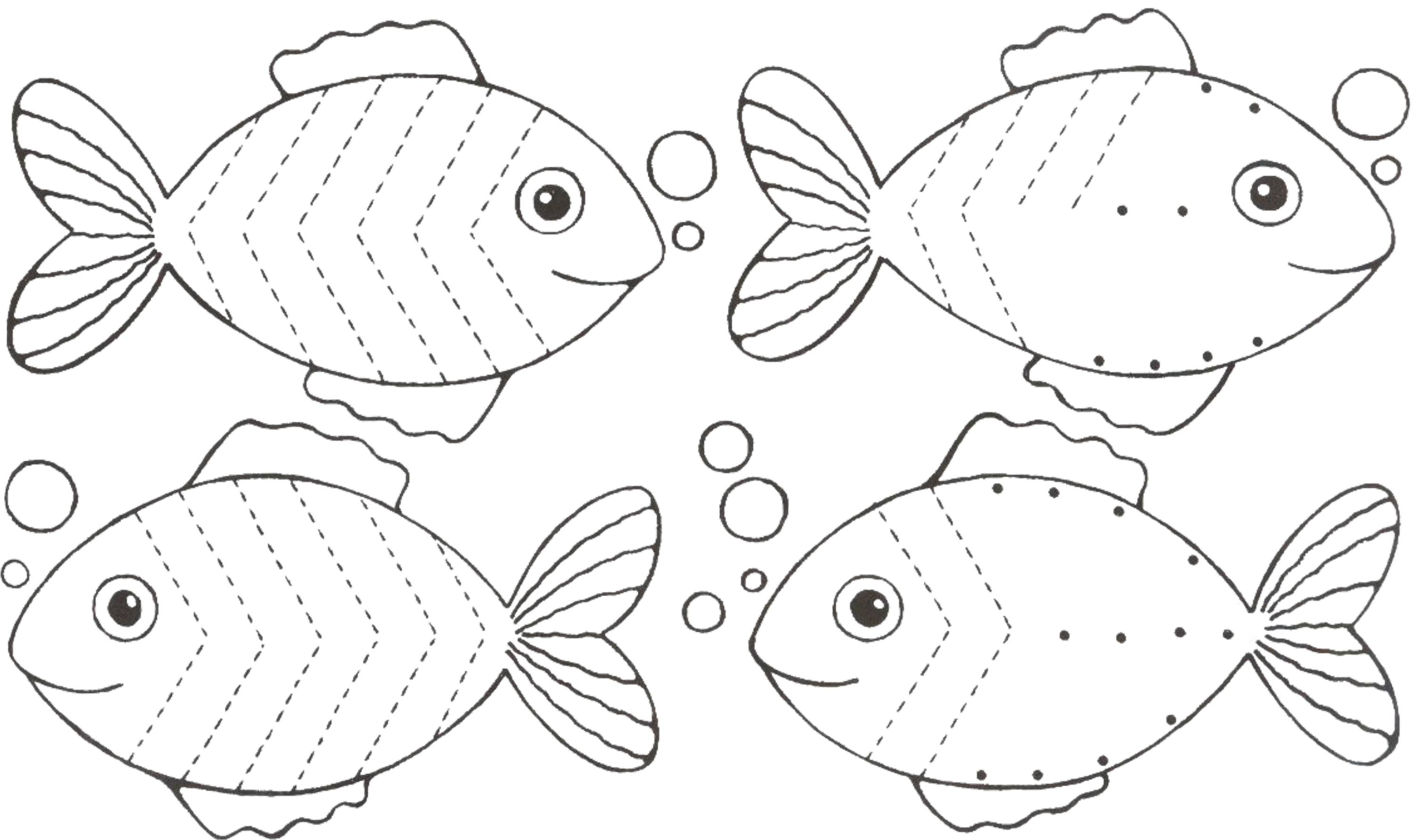
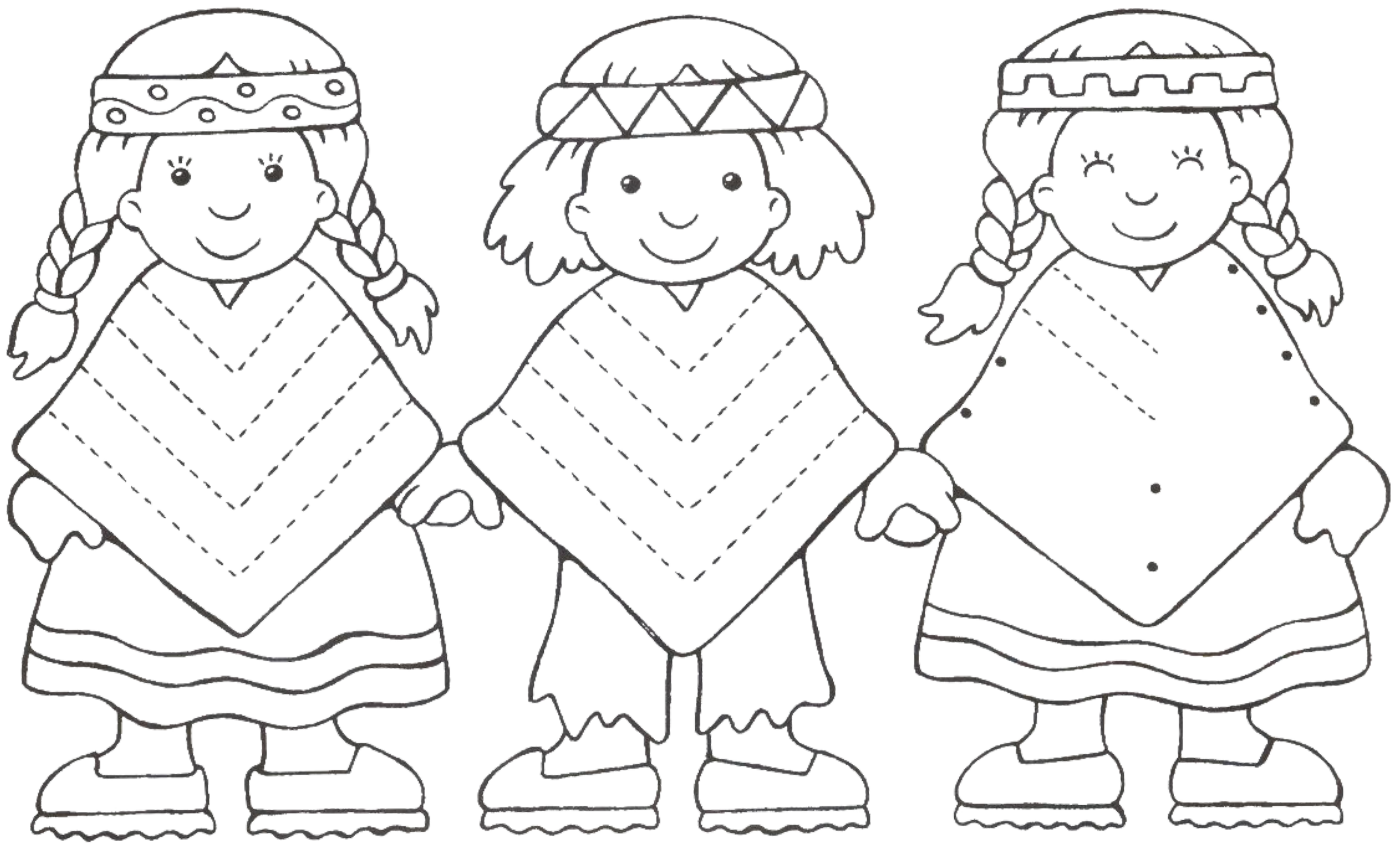

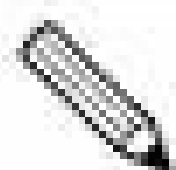

Jak pišou indiáni? Vyzkoušej to.

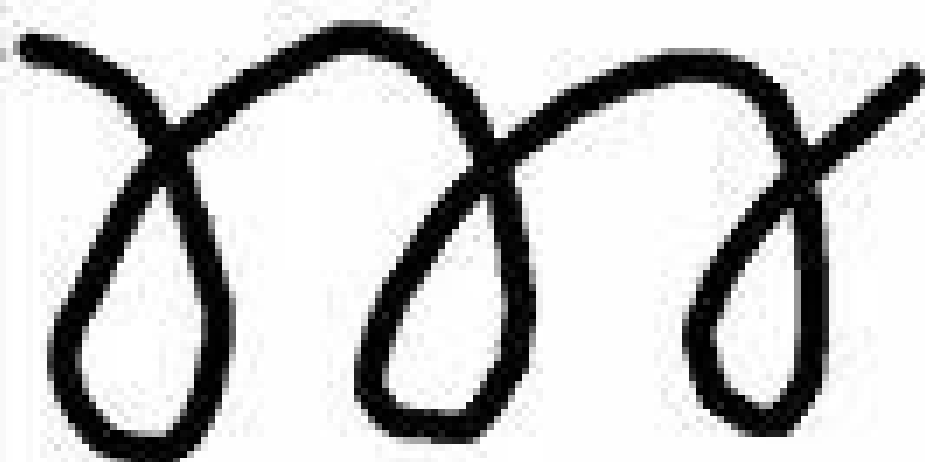
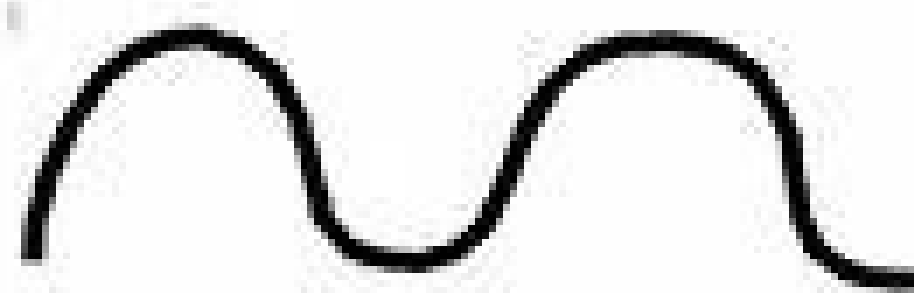



Aşağıdaki görsellerin eksiklerini baştaki görsele bakarak tamamlar mısın?

