

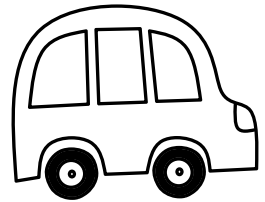

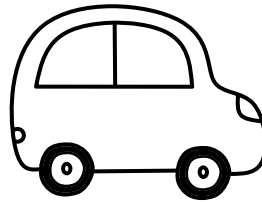

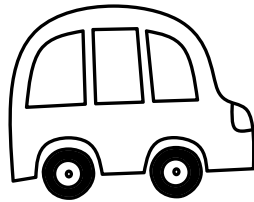

Aşağıdakilerden farklı olanı bulur musun?

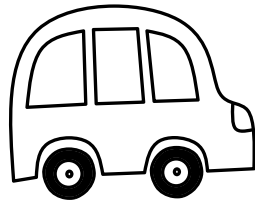
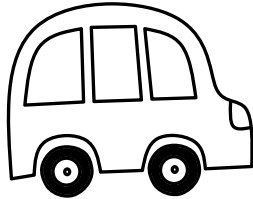
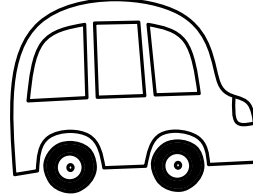
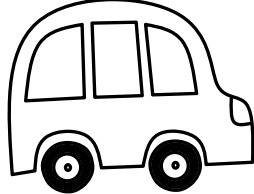
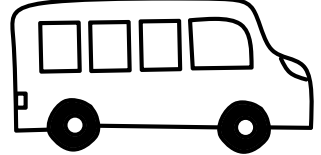
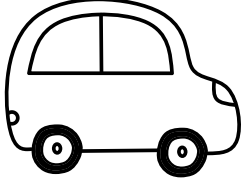
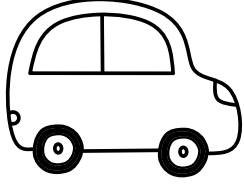
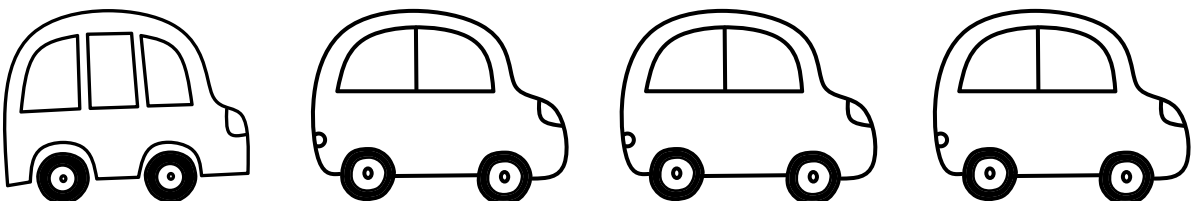
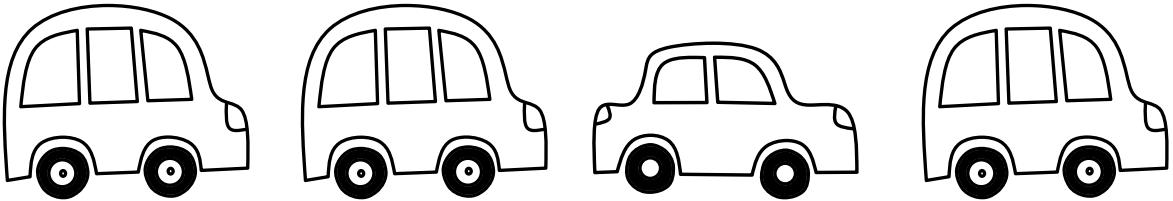
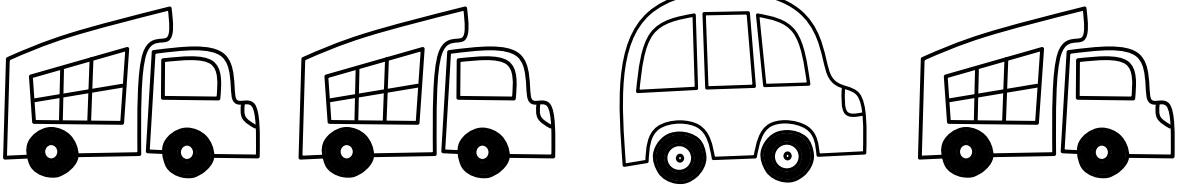
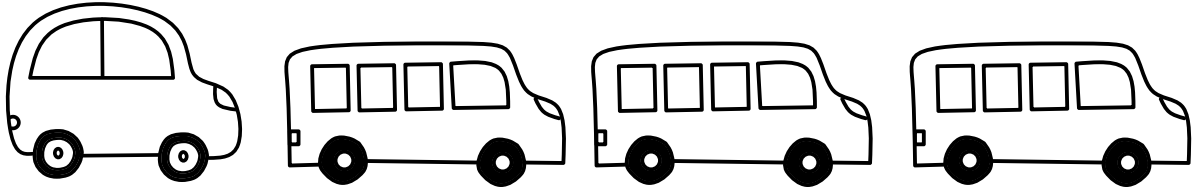
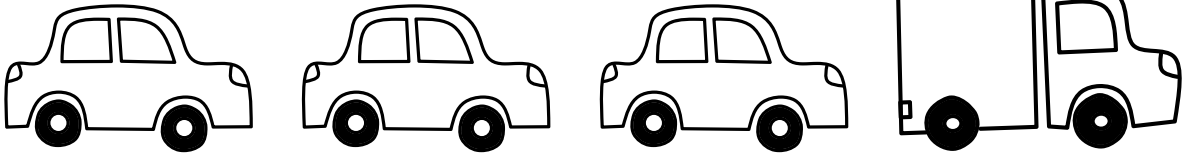
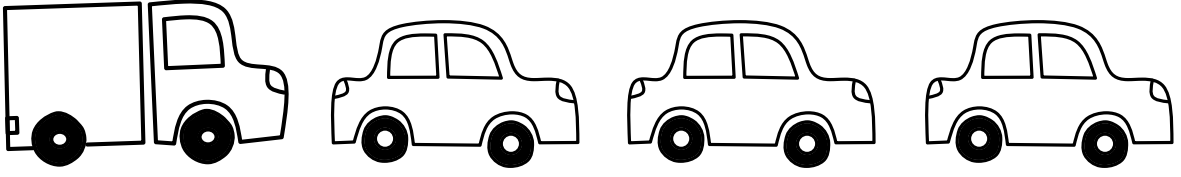
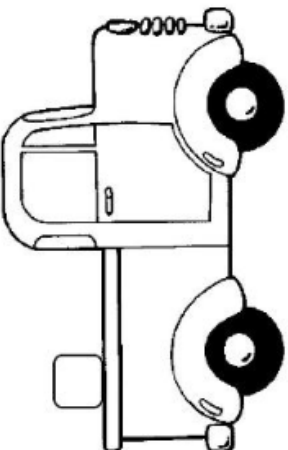
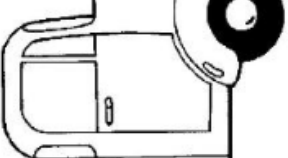



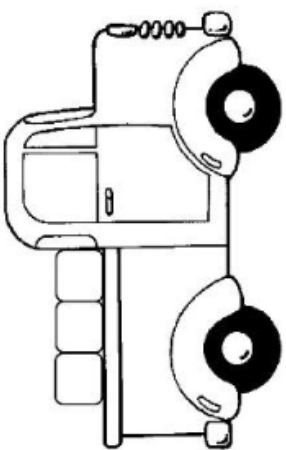
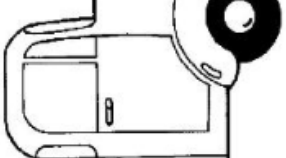

Aşağıdakilerden farklı olanı bulur musun?



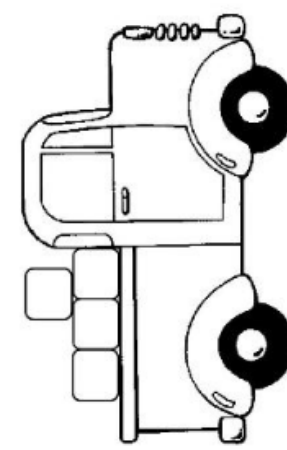
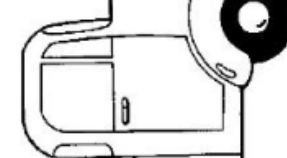
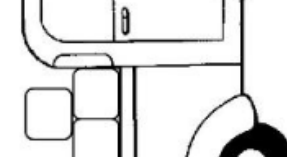

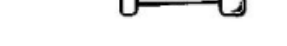

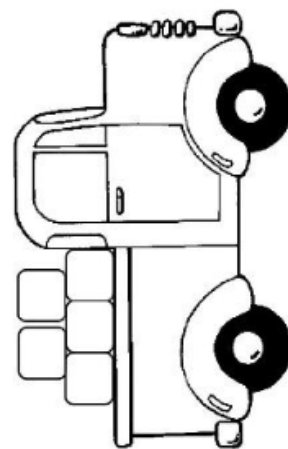
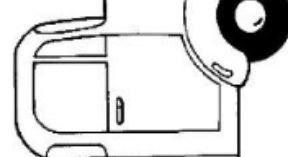
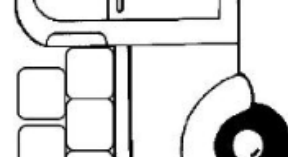

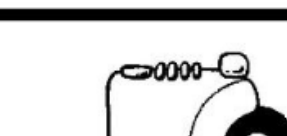

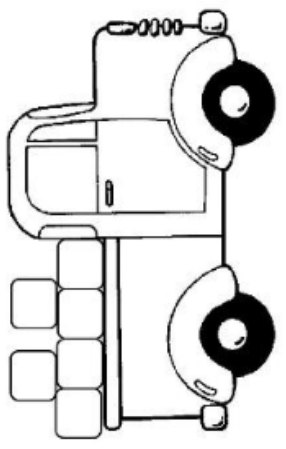
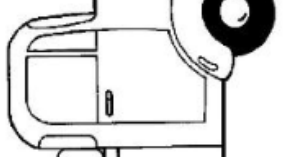
	2
	4
	5

	3
	1
	4
	2
	5

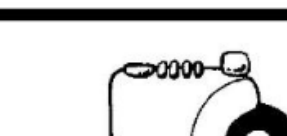
	2
	1
	4
	5
	2

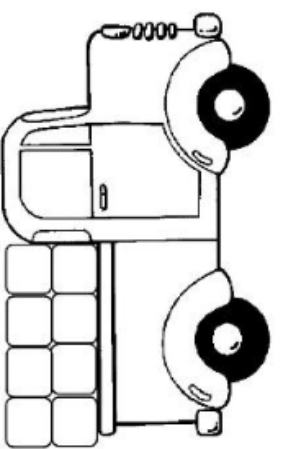
	2
	6
	4
	1
	5
	6

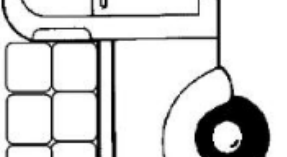
	8
	6
	7
	5
	8
	6

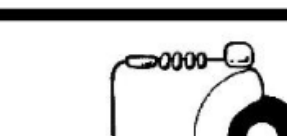
	9
	10
	8
	6
	10
	7

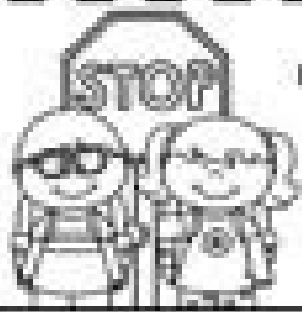

Name _____

Transportation Counting

Directions: Count the items. Fill in the correct circle.

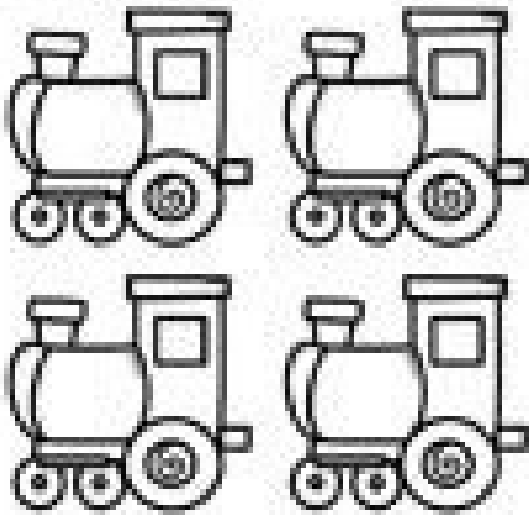

3

5

4

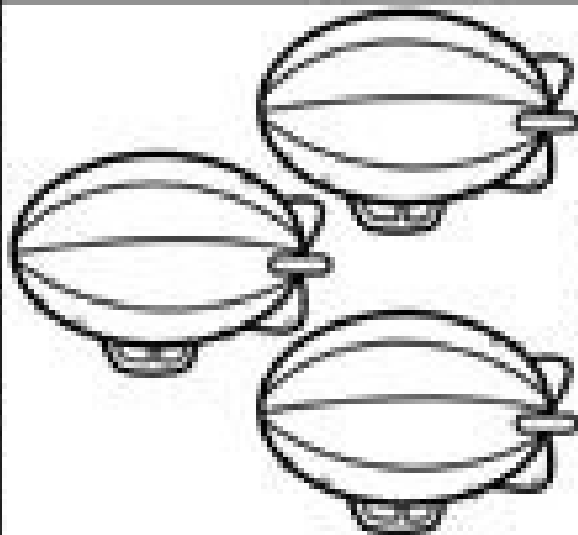

3

5

4

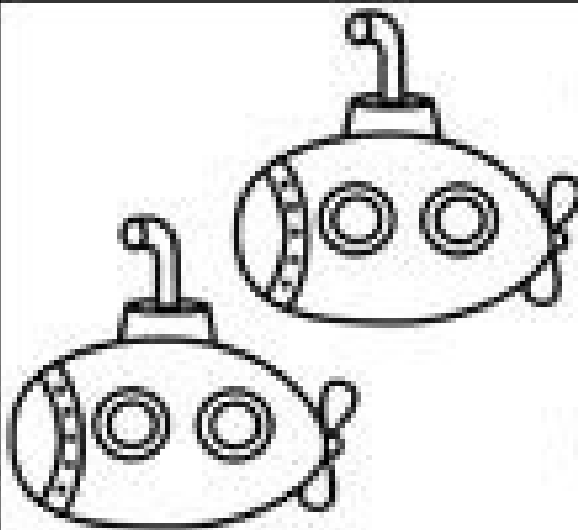

1

2

3

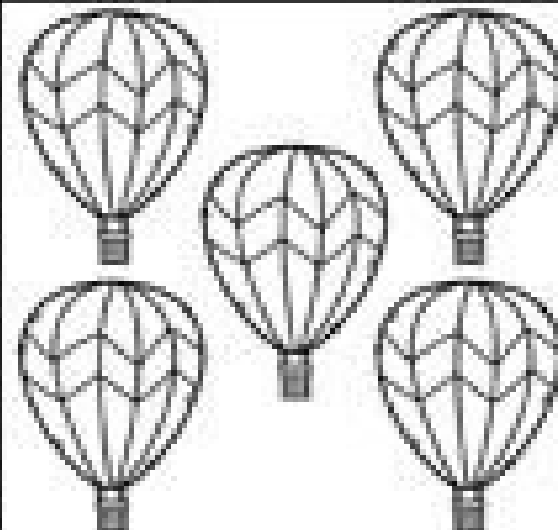

3

5

4

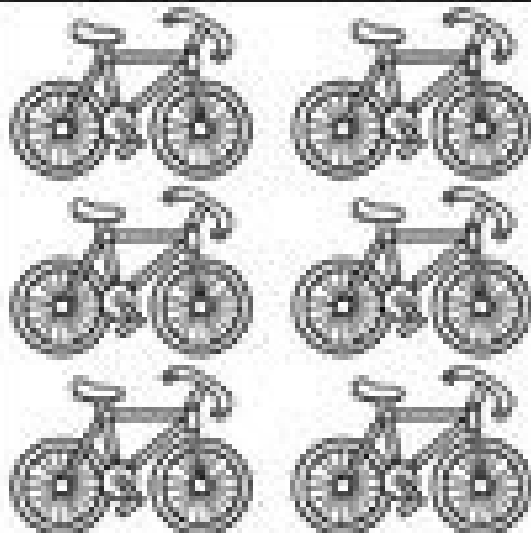

6

5

4



3

2

1

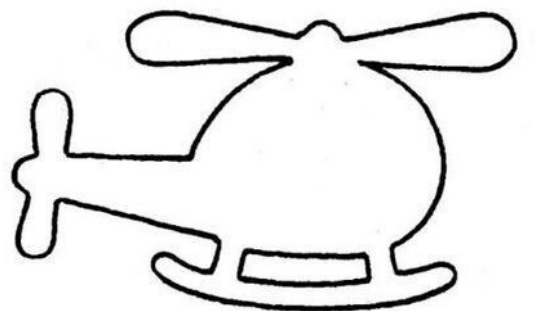
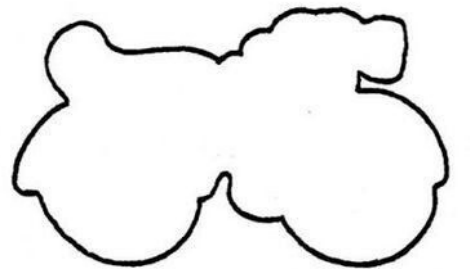
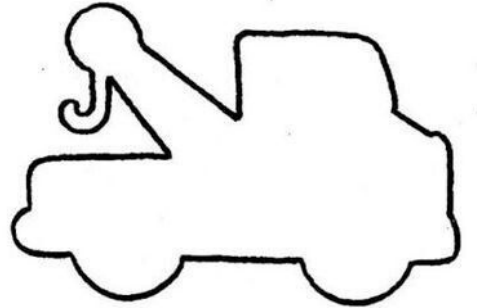
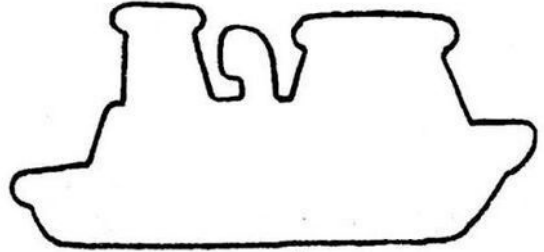
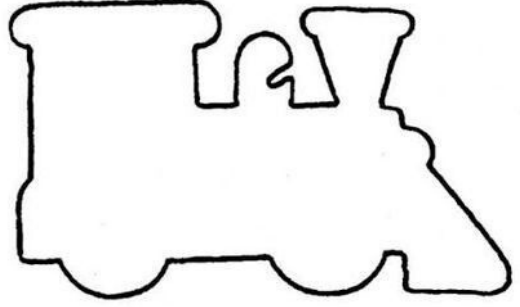
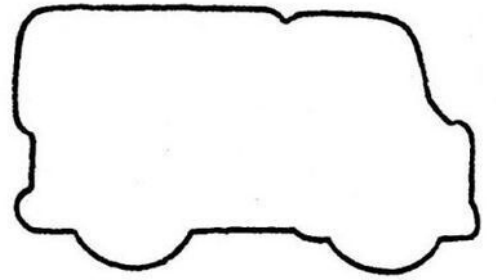
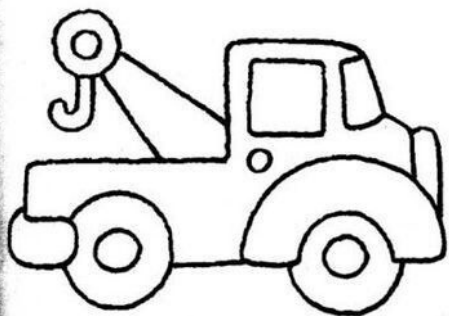
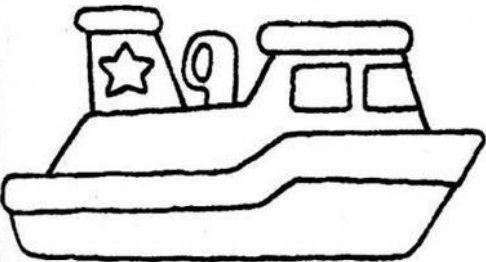
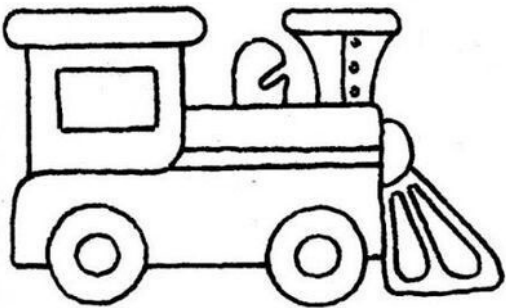
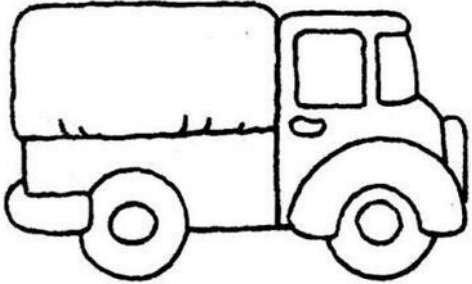
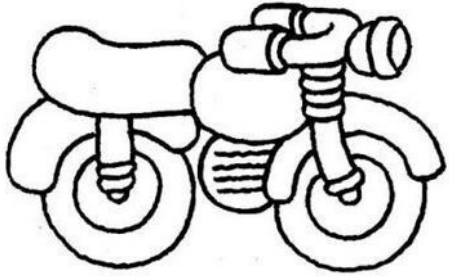
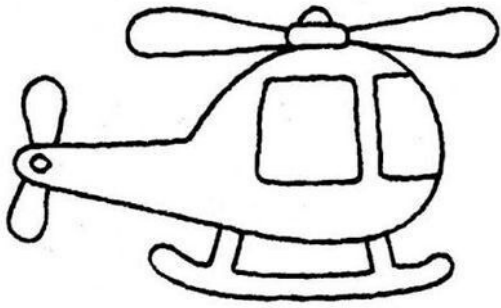

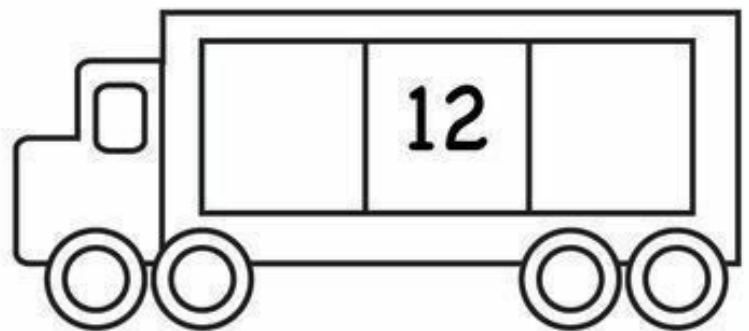
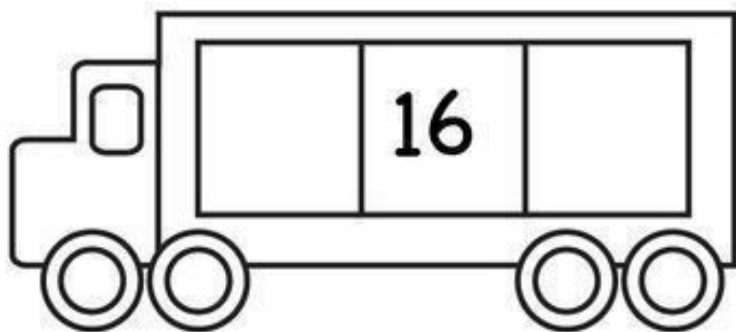
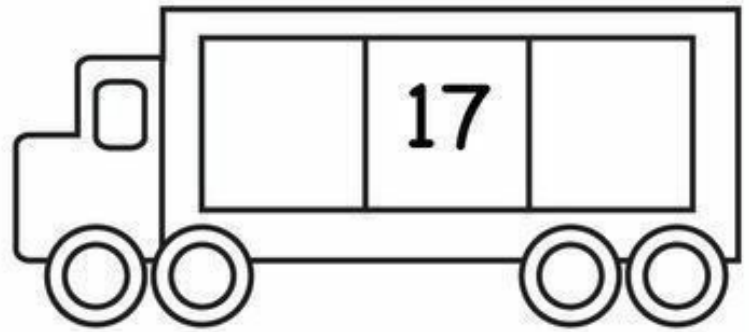
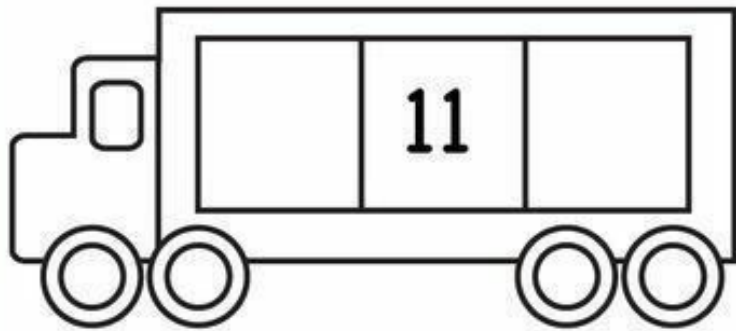
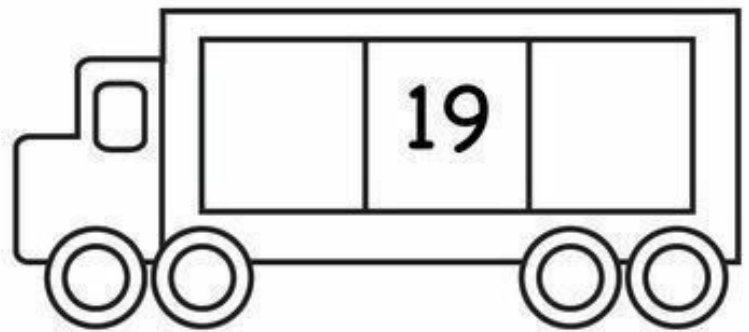
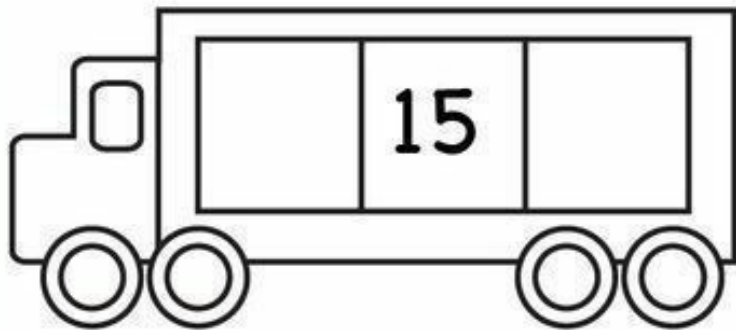
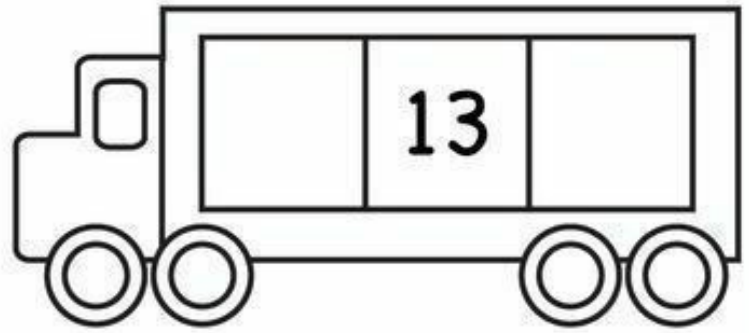
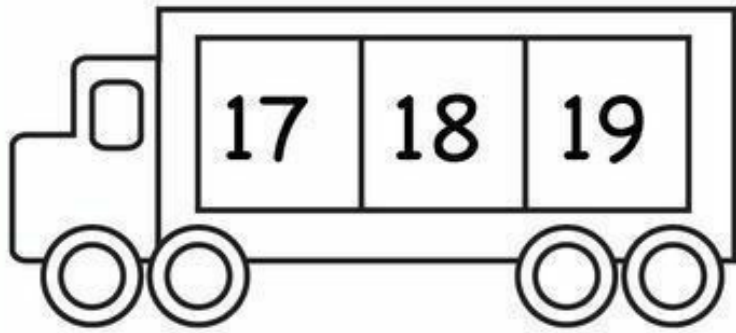

Name _____

Transportation Pattern Practice

Directions: Cut out the correct picture to complete each pattern.

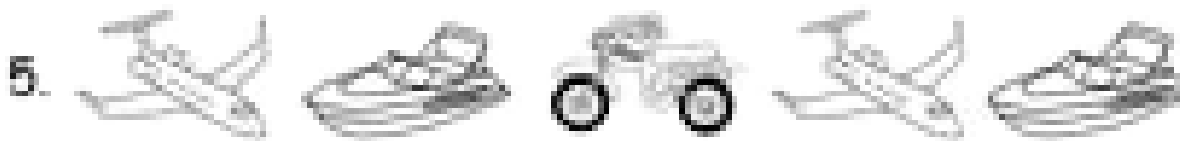

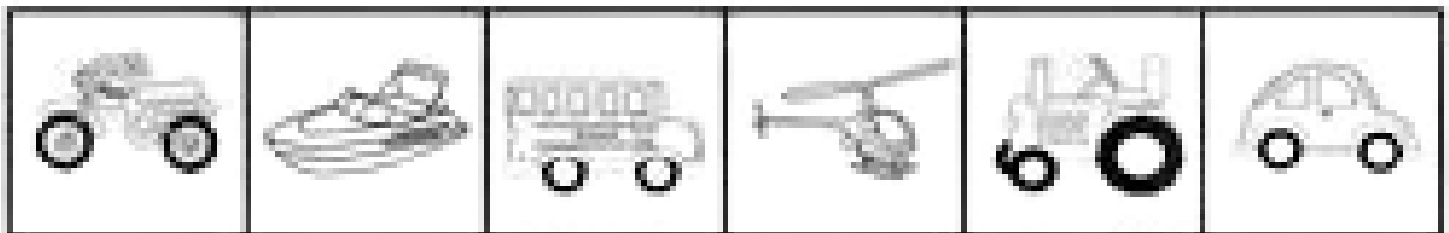



Nama : _____

Hari : _____

Tarikh : _____

Kenderaan Darat

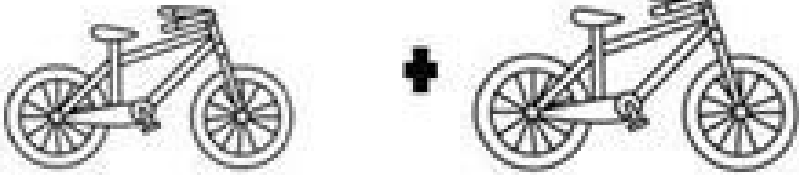
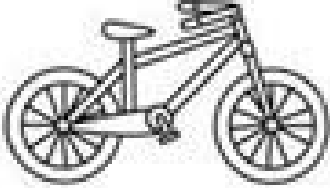
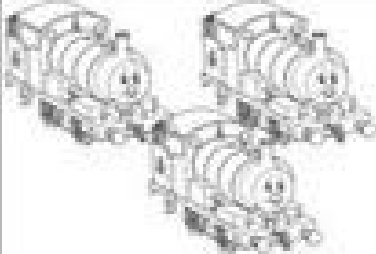
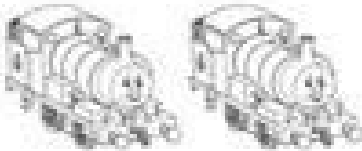
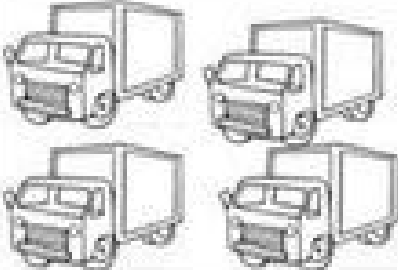
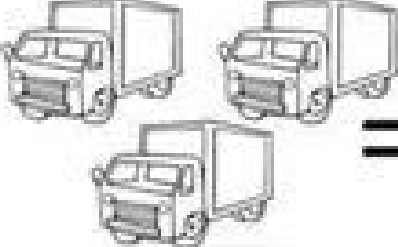
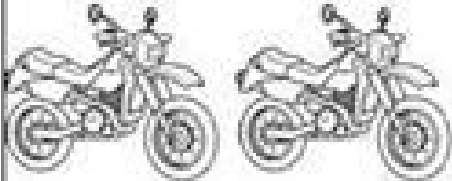
Gunting hasil tambah dan tampal pada ruang yang betul.

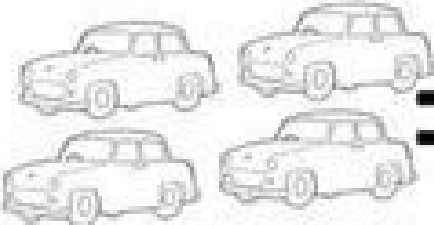
	$+$		$=$	
	$+$		$=$	
	$+$		$=$	
	$+$		$=$	
	$+$		$=$	

Penyaji B.B.M

8

5

4

7







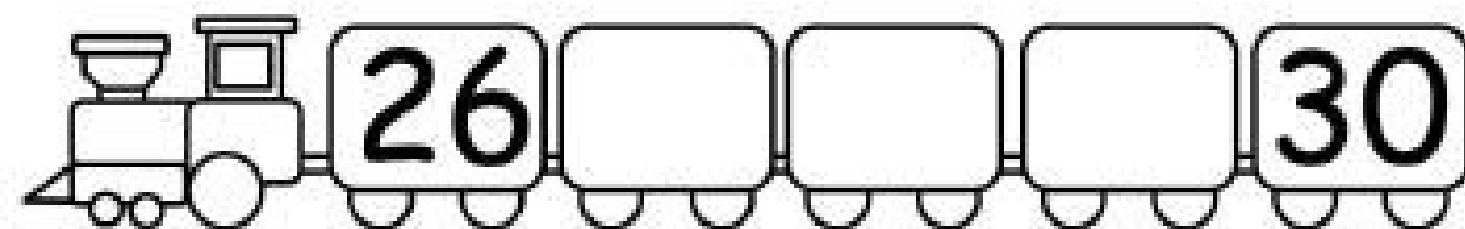
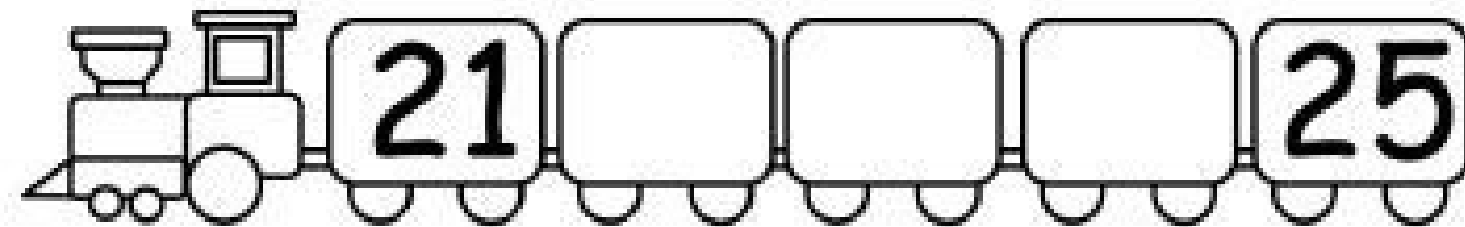
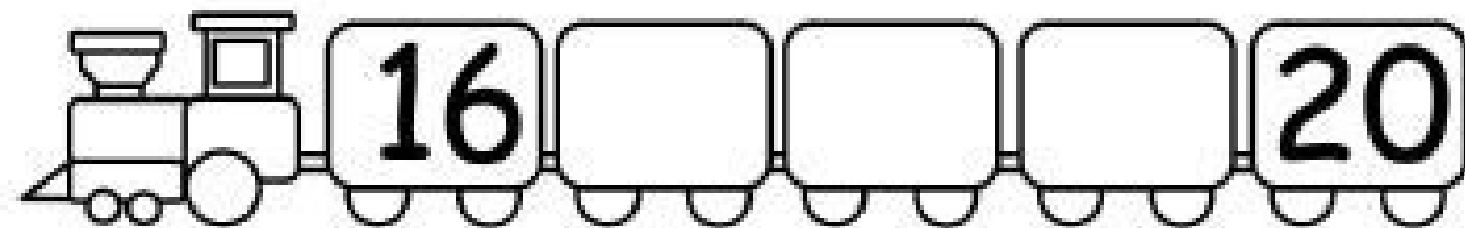
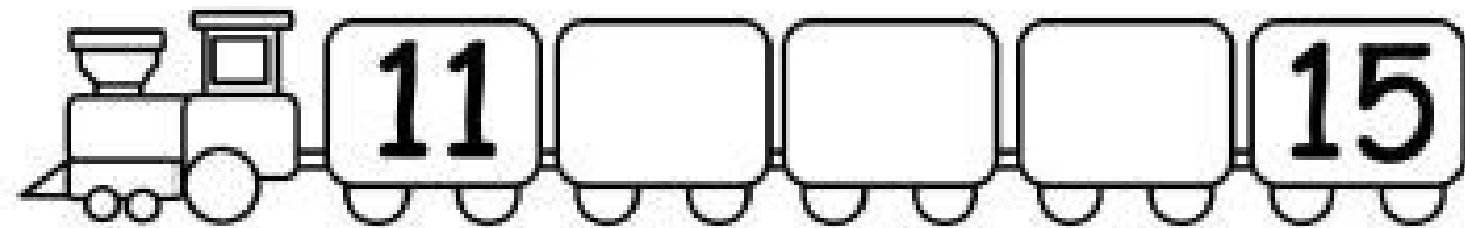
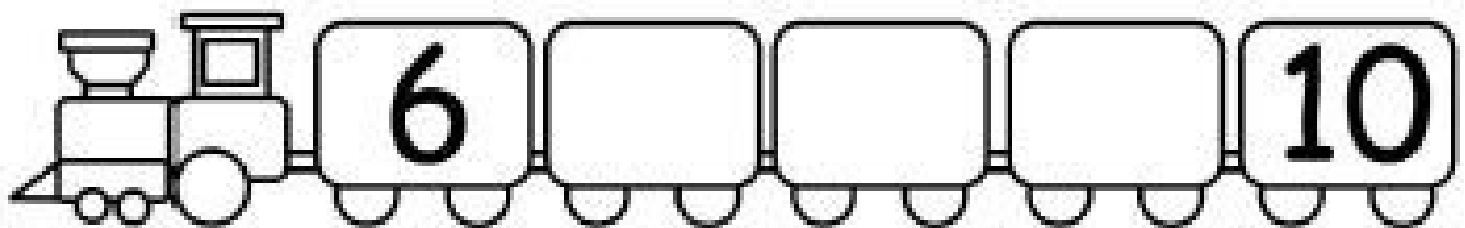
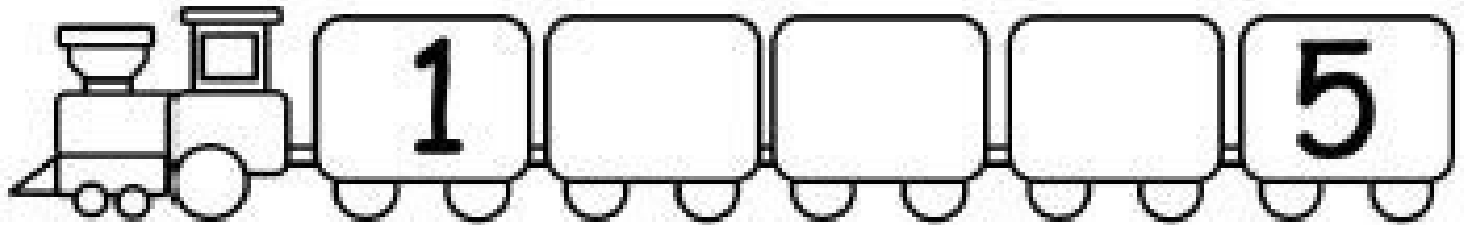







2

Number Trains

Write the missing numbers in each row.

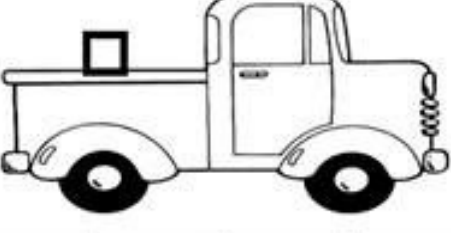

KAMYONLARDAKİ KASALARI SAY VE KASA SAYISINI X İŞARETİ İLE İŞARETLE.

		
2 3 1 4	3 4 6 2	6 4 5 8
		
3 6 7 2	7 6 5 4	4 5 2 1
		
7 8 5 6	8 7 9 6	5 4 3 6
		
3 2 1 6	3 2 4 5	7 9 8 10
		
3 1 2 4	7 6 4 3	4 6 5 7

VERVOER: Tellen en cijfers (1 t/m 5)

Kijk naar het cijfer en kleur het goede aantal plaatjes.



KleuterArchief.nl

3



4

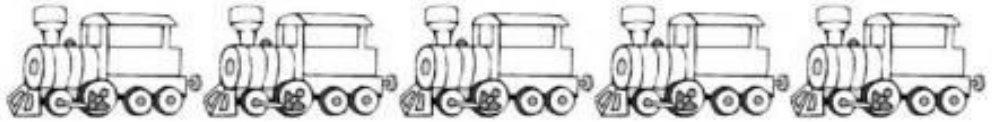

1



5



2



3



4

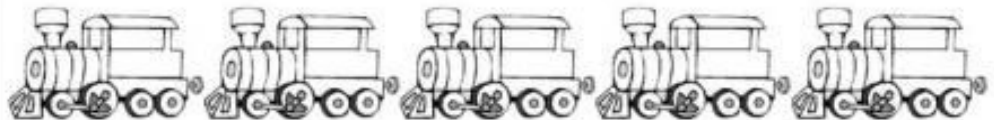

5



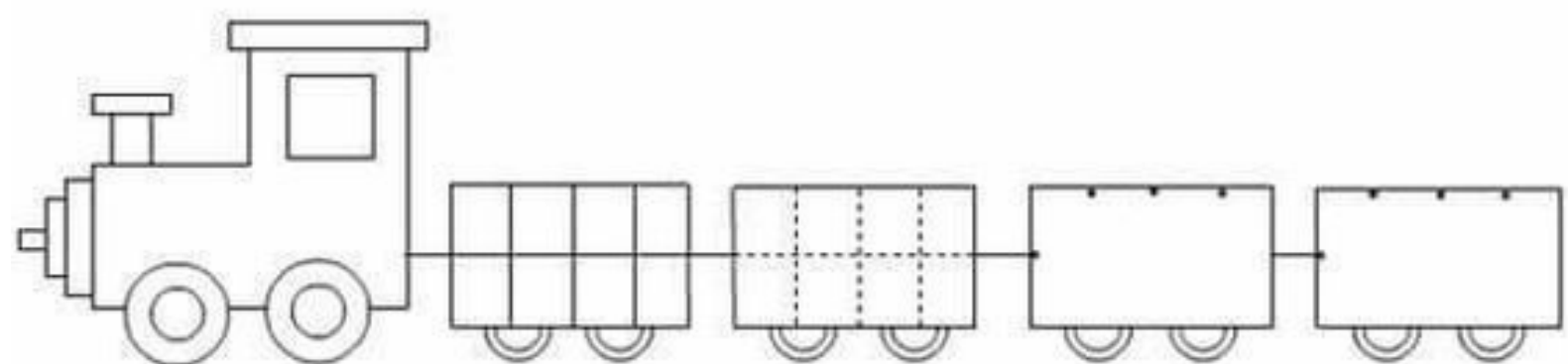
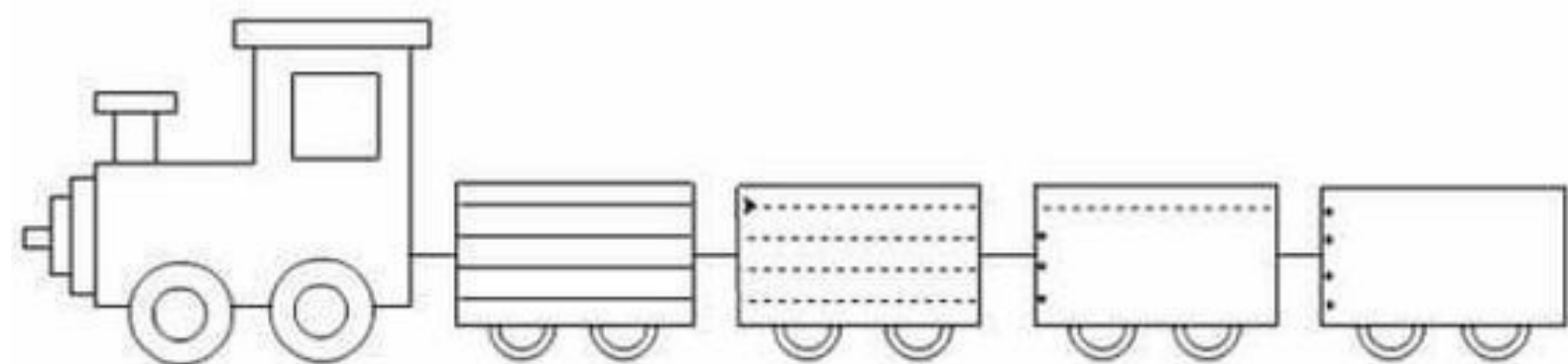
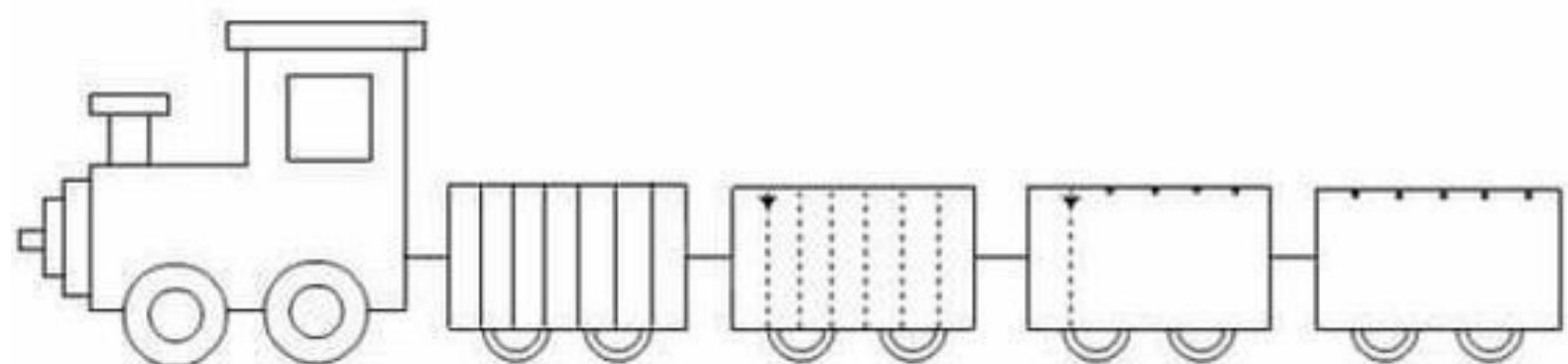
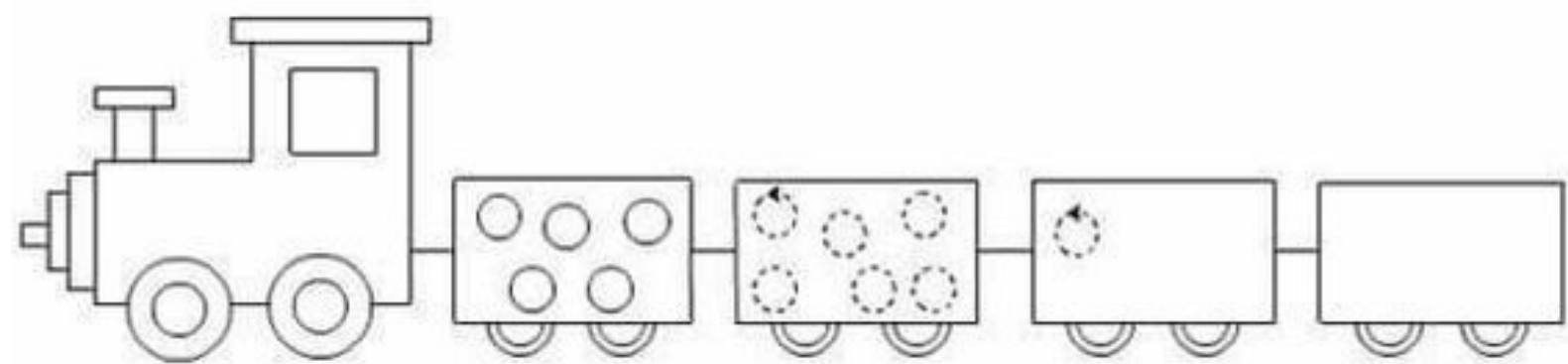

FINISH

Trace to Race

Trace the lines to help the cars get to the finish line.

The activity consists of five toy cars at the bottom, each with a dashed line path leading to a banner at the top labeled 'FINISH'. The paths are: 1) A square path with arrows indicating a clockwise loop. 2) A wavy path with arrows indicating a back-and-forth wave. 3) A zigzag path with arrows indicating a series of 'V' shapes. 4) A path with three circles and a vertical line, with arrows indicating a circular path around the first circle and an upward path. 5) A wavy path with arrows indicating a back-and-forth wave.

